

Best Practices in **OPERATION AND MAINTENANCE** of Rooftop Solar PV Systems in India



Second Edition

Copyright © 2018

All rights reserved. No part of this publication may be reproduced, distributed, or transmitted in any form or by any means, including photocopying, recording, or other electronic or mechanical methods, without the prior written permission of the publisher, except in the case of brief quotations embodied in critical reviews and certain other noncommercial uses permitted by copyright law.

Published in May, 2018

Authors

JAYA VASITA

Project Fellow

Gujarat Energy Research & Management Institute

AKHILESH MAGAL

Head Solar Advisor

Gujarat Energy Research & Management Institute

ABOUT THIS HANDBOOK

This handbook came about as a result of our discussions with several stakeholders in the Indian solar market. While there is much enthusiasm and excitement about India's thrust towards renewable and especially solar energy, there were also some concerns about the quality of the installations. The concern is especially amplified in the rooftop solar segment, which tends to be privately owned, especially by the common man who has a notion that solar is a "fit-and-forget" technology. Despite the relatively minimum maintenance requirements of rooftop solar PV systems, they do need some care and attention. Safety of installations as well as the upkeep of the systems tend to be often overlooked, which can become very dangerous and end up bringing a bad name to the technology. It was amidst these concerns, that the idea for this handbook was born. Gujarat Energy Research and Management Institute (GERMI) has been actively involved in the rooftop solar deployment and dialogue across many states in India since 2008. As a part of our commitment to the solar community - investors, developers, entrepreneurs, policy makers and consumers - we felt it apt to come out with a simple, yet comprehensive guide to rooftop solar PV maintenance. In our initial discussions, we were quite clear that we did not want another text heavy document. We intended to bring out a clear, consistent, graphical and picture oriented handbook which can be easily digested by the common folk. In that effort, we recognize that we might have oversimplified a few details - for which we

ask for a little leeway. It is also quite difficult to address an audience as wide - from a system installer to a common man. Therefore, throughout the manual you will find sections differentiated as beginner and expert. This is especially needed because some of the tools and maintenance procedures can only be handled by experts with the appropriate tools and safety gear. The beginner must not try to attempt it. However, our intention is to educate the technically oriented common man, so that there is at least an ounce of awareness as to what is wrong and what steps need to be taken. The manual's structure reflects a typical rooftop solar PV system. We have divided chapters according to PV modules, inverters and balance of systems (mounting structures, cables, etc.). We have also included a chapter on safety, which is critical and often neglected. There is also a section on how to read the bill - a crucial aspect especially for those customers who are new to rooftop solar or perhaps even to reading a bill. Finally, a chapter on documentation is also included with the aim that the maintenance checklist and other records are kept judiciously. Our hope is that this manual is received well by all who read it. We especially thank our sponsors for having the faith in us to come out with something this comprehensive. We are indebted to them for their support both financially and technically for this handbook. While the handbook is a result of a plethora of inputs, any shortcomings are our responsibility. We are open to feedback and improvement.

FOREWORD I

Gujarat has been a pioneer in solar energy. It was the first state to introduce a dedicated solar energy policy and also implement the first megawatt scale rooftop program in the country. The 5 MW Gandhinagar rooftop solar PV program has been a successful model that has been replicated across many states and cities in India. The Government of Gujarat is dedicated to the development of the solar sector, especially rooftop and is committed to the long term success of this sector in the state. The deployment of solar installations for homes was initiated by Gujarat Energy Development Agency (GEDA) under the guidance of the Energy and Petrochemicals Department (EPD), Government of Gujarat. By 2021-22 the state has set a target of generating 3200 megawatt (MW) of electricity by installing rooftop solar photovoltaic (SPV) units across Gujarat. The Government of Gujarat has implemented various subsidies to attract rooftop owners towards rooftop solar installation. The subsidy is over and above the subsidy provided by the Ministry of New and Renewable Energy (MNRE). For every individual household connected to the grid, the policy provides a subsidy of INR 10,000 per kW capped to a ceiling of INR 20,000. This scenario becomes a double-benefit subsidy for a home-owner, since an eligible applicant can avail the subsidy provided by both the central and state governments.

With the installed capacity of rooftop solar PV growing progressively, the maintenance of these installations is becoming increasingly relevant. To ensure the quality of a rooftop system for a sustained period of time, it becomes extremely important to focus on its Operation and Maintenance (O&M). It is the most appropriate time that GERMI has come up with this handbook which will serve as a guide for government agencies, investors, banks, EPC, and O&M companies and most importantly homeowners. It aims at providing best practices in operating and maintaining the rooftop solar systems. This will ensure that the systems last for their entire life-cycle. From the government's perspective, it translates to subsidy that is well spent.

I am happy that GERMI has taken the stewardship of coming out with this handbook and am confident that this Handbook will reach the relevant stakeholders which would ensure that the rooftop systems deployed in Gujarat and across India perform optimally.



Shri Sujit Gulati (IAS),
Additional Chief Secretary
Energy and Petrochemical Department,
Government of Gujarat

FOREWORD II

The Government of India is aiming towards a capacity of about 100,000 MW to come from solar energy by the year 2022. This includes a capacity of 60,000 MW to come up as solar parks and utility scale solar photovoltaic power plants, and 40,000 MW to come up on the rooftops of various commercial, industrial and residential buildings spread throughout the country. Solar photovoltaic has seen a tremendous growth over the last few years globally and Indian solar industry has been a success story in itself.

You have in front of view the best practice guide for Operation & Maintenance (O&M) of Solar PV Power Plants conceptualized and implemented by Gujarat Energy Research and Management Institute (GERMI). The manual showcases the various aspects to be emphasised during the O&M phase and has been designed to enable theoretical and practical training on Operation and Maintenance aspects of Solar PV Installations. Efforts have been made to revise the knowledge of electrical and civil concepts required for this job along with the operating principles and specifications of all solar PV power plant components.

The contents of this book are in simple language with lots of pictures explaining the critical aspects for practical applications, without going into too much theoretical details and calculations. It is envisaged that this manual will provide participants with the knowledge and skills required for operating and maintaining a solar photovoltaic power plant, complying with all applicable codes, standards, and safety requirements; and enable them to actively participate in the growing solar market.

The best part of this manual is its two-way approach of technical writing, where every unit, is divided into two chapters. Chapter 1 deals with the component and chapter 2 deals with the maintenance, troubleshooting and related

aspects. The detailing of practical case studies makes the understanding of the topic easier and comprehensive for immediate application. Safety is a very critical area during operation and maintenance as the plant is installed and commissioned and generating enough electricity to electrocute a person if there is any fault undetected. I am pleased to see that there has been a dedicated unit to jobsite safety. Unit 5 details the general safety procedures and personal safety procedures to be followed while working on the site. Additionally, Unit 6 gives the details of how to read and interpret the electricity bills that can be used to explain the performance of the plant with proper maintenance and no maintenance. Lastly, whatever has been done on site should be recorded, and hence, Unit 7 deals with the documentation aspects of the O&M and what all documents are required to be kept and prepared including their individual importance. Skill Council for Green Jobs would like to express their gratitude to GERMI for their never-ending thrust for quality skill development to support the growth of solar sector. This manual is dedicated to all the aspiring candidates who desire to achieve specific skills which would be a lifelong asset for their future endeavours and help them make a bright career in the O&M domain.

With best Regards,



Tanmay Bishnoi, CEng, MLESM

Head - Standards and Research

Head - Curriculum and Content Development

Skill Council for Green Jobs

(The Apex body for green skills
development and certification in India)



TABLE OF CONTENTS

UNIT 1

INTRODUCTION TO SOLAR PV OPERATION & MAINTENANCE **19-43**

CHAPTER 1	Why is O&M needed?	20
1.1	Expected Outcome	20
1.2	Benefits of O&M	21
CHAPTER 2	Overview of PV System Components	22
2.1	Types of Rooftop PV Systems	22
2.2	System Components	24
CHAPTER 3	Maintenance Categorization	34
3.1	Scheduled Maintenance	34
3.2	Unscheduled Maintenance	36
CHAPTER 4	Common Tools & Equipments Used	37
4.1	Testing Methods & Techniques	40



UNIT 2

PHOTOVOLTAIC MODULES **49-81**

CHAPTER 1	Inspection & Fault Identification	49
1.1	Dust accumulation	49
1.2	Module Shading	52
1.3	Module Mismatch	56
1.4	Physical Integrity	57
CHAPTER 2	Maintenance & Troubleshooting	59
2.1	Basic Level	59
2.2	Advanced Level	64
2.3	Methods & Techniques for Shading Analysis	67
2.4	Key Points to Remember	81

UNIT 3

INVERTERS

87-109

CHAPTER 1	Inspection & Fault Identification	87
1.1	Classification of Solar Inverters	87
1.2	Routine Inspection	92
CHAPTER 2	Maintenance & Troubleshooting	99
2.1	Basic Level	99
2.2	Advanced Level	103
2.3	Key Points to Remember	109

UNIT 4

BALANCE OF SYSTEMS

111-145

CHAPTER 1	Inspection & Fault Identification	111
1.1	Cables	111
1.2	Protection Devices	112
1.3	Batteries	116
CHAPTER 2	Maintenance & Troubleshooting	117
2.1	Basic Level	117
2.2	Advanced Level	136
2.3	Key points to Remember	145



UNIT 5

JOBSITE SAFETY	149-159
CHAPTER 1 General Safety Procedures	149
1.1 General safety	149
1.2 Specific safety	150
CHAPTER 2 Personal Safety Procedures	151
2.1 Importance of Personal Protective Equipment	151
2.2 Major Safety Hazards	151
2.3 Key points to Remember	159

UNIT 6

READING YOUR ELECTRICITY BILL	161-167
CHAPTER 1 Calculating consumption of electrical energy	161
CHAPTER 2 Calculating energy generated by my RTPV system	163
2.1 Before Installing Solar	165
2.2 After Installing Solar	166

UNIT 7

DOCUMENTATION	169-171
CHAPTER 1 Importance of Documentation & its significance	169
1.1 System Documentation	169
1.2 Maintenance Documentation	170
1.3 Component Documentation	171



UNIT 1

INTRODUCTION TO SOLAR PV OPERATION & MAINTENANCE

WHAT WILL WE LEARN?

- Solar Photovoltaic (PV) O&M Needs & Benefits
- Overview of PV Systems & Components
- Maintenance Categorization
- Common Tools & Equipments Used

Operations and Maintenance (O&M) is an integral part of any Rooftop Solar PV System. Although a rooftop solar PV plant requires little day-to-day maintenance, it is important to ensure that the system is well maintained and is performing at an optimal level.

This section highlights the need for O&M in a rooftop solar power plant. It describes the importance of maintaining a RTPV system since this ensures a longer lifetime, efficient allocation of subsidy from the Government's perspective and ultimately provides a better

return on investment for the investor or the owner. Universally, there is a widespread notion that solar power plants demand exceptionally less or no maintenance at all. This statement is in fact, true to some extent but at the same time also is misleading. Solar power plant is an asset that is likely to last nearly 20-25 years. Ultimately when it comes down to an investment strategy, one must account for O&M issues and at the same time deal with these issues in the most efficient and cost effective way.

CHAPTER 1

Why is O&M needed?

The main aim of O&M is to increase the plant's lifetime and maintain efficiency. Since a RTPV system is an electrical system with both AC and DC components usually at appreciably high voltages, safety also becomes a prime concern for which proper O&M must be performed. By ensuring O&M at appropriate time intervals, one can minimize the losses and increase the energy production from the plant. The following sections highlight the best practices in O&M mainly for rooftop plants, but some of these are equally applicable to larger ground mounted plants as well.

EXPECTED OUTCOME

The expected outcome from the handbook shows the identification and analysis of factors causing degradation and common faults in Solar PV along with operation and

maintenance experience and challenges to prevent generation interruptions and estimation of energy generation for future energy security. This handbook is prepared to keep in mind the maintenance strategies and methods so one can evade loss of energy generation.

The lack of awareness on behalf of both owners of such systems and installers could jeopardize India's 40 GW solar goal.

The need of the hour, therefore, is to bring out a simple, lucid and graphical handbook that would:

1. Aid installers and engineers to follow the best practices in operating and maintaining rooftop solar PV systems such that their electrical output and life are maximized.
2. Empower homeowners with adequate know-how about their rooftop solar PV system maintenance such that they can hold their installers accountable.
3. Serve as a guide to bankers, investors and Governments to ensure that the systems they finance are optimally maintained.

BENEFITS OF O&M

Breakdown
elimination

Extends Plant's
life

Increases revenue

Increases energy
generation

Lesser maintenance
costs

Improved safety

Some Common Questions That Arise

- 1 How many types of maintenance approaches are there?
- 2 Who will maintain my PV system?
- 3 What level of operation and maintenance is needed to ensure performance without wasting money on unnecessary measures?
- 4 How much should I budget for operation and maintenance?

The answer to these question depends on location, condition and circumstances. This handbook will help in answering these questions.

CHAPTER 2

Overview of PV System Components

TYPES OF ROOFTOP PV SYSTEM

This section describes the common types of RTPV systems and the components that are necessary. This section is primarily aimed at the homeowner in order to get a better idea about the RTPV system. It gives an overview and highlights the importance of each component in the system.

Stand Alone PV Systems (for places with no grid electricity)

Stand-alone PV systems, which are isolated from the distribution grid usually, use stand-alone inverters with batteries. The figure 1

shows a stand-alone system with both DC and AC loads and figure 2 shows a stand-alone system with only DC loads.

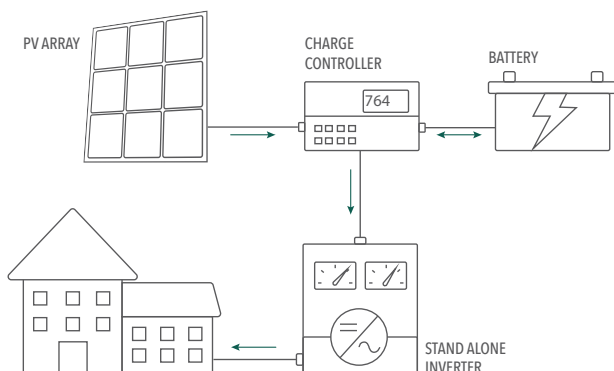

Figure 1: **Stand-alone system with both DC & AC loads**

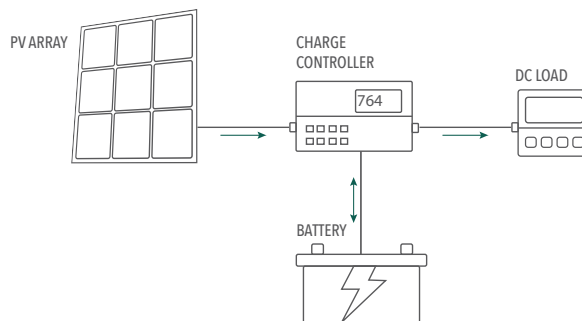

Figure 2: **Stand-alone system with only DC loads**

Grid Connected PV Systems (grid present, no or not many power cuts)

Grid-connected PV systems (also known as grid-tied systems), which are directly connected to the distribution grid, use grid-connected inverters, and usually do not use batteries. These systems are capable of exporting surplus power into the distribution grid. A grid-connected PV systems is designed to automatically shut down if it detects anomalies in grid parameters such as voltage, frequency, rate of change of frequency, etc.

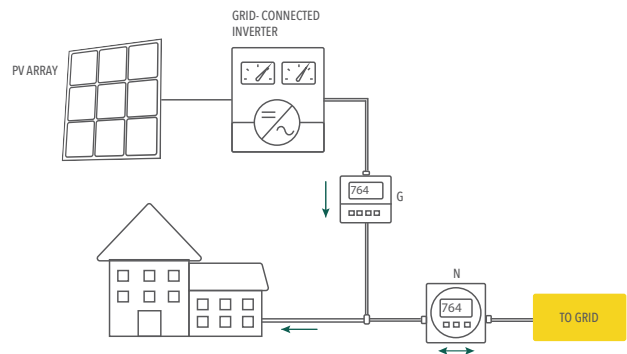

Figure 3: **Grid connected PV System**

Hybrid PV Systems (grid present, but several power cuts)

Hybrid PV systems are connected to the grid and also have a battery backup. If a hybrid PV system observes anomalies in grid parameters, it is designed to isolate the consumer from the grid and continue to supply power from the PV system and batteries. The batteries can be charged by the grid or by solar energy in such systems.

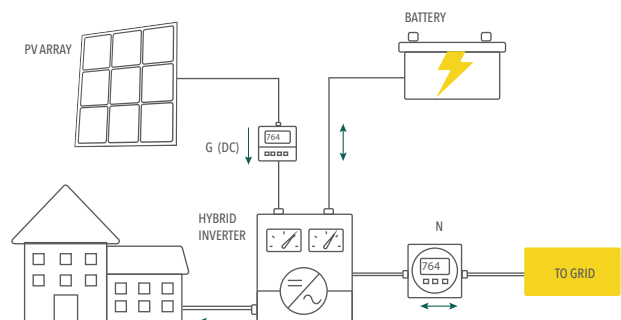

Figure 4: **Hybrid PV System**

SYSTEM COMPONENTS

PV Modules

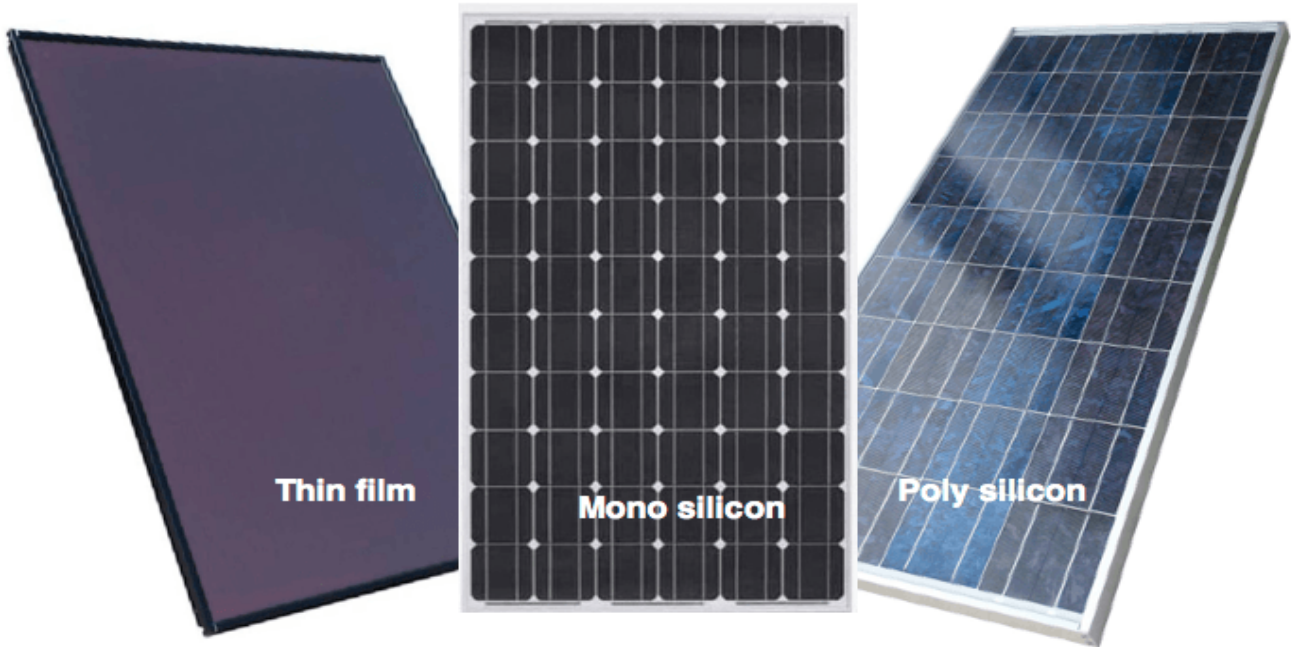

Figure 5: **Photovoltaic Modules**

PV Modules convert sunlight directly into DC electricity. Solar cells (which are normally made of crystalline, polycrystalline or amorphous silicon or other compound semiconductors like Cadmium Telluride-CdTe and Copper Indium Gallium Selenide-CIGS) are connected in series and encapsulated in a PV module. PV modules are rated for a particular power capacity at standard testing conditions (STC), which is also indicated on its label. In the market, different modules are used depending on cost and technical considerations. These are predominantly identified according to their cell type:

- Monocrystalline
- Polycrystalline
- Thin-film (Amorphous, micro crystalline, CdTe or CIS Modules)

The specifications of a module are provided by the manufacturer on a nameplate given behind the module. The safety and quality of the PV module is ensured through appropriate certifications, warranties and guarantees. PV modules typically carry a performance warranty of 90 percent of the nominal power output for the first 10 years, and 80 percent for the next 15 years. The workmanship warranty on the PV module is typically for 5 years and covers against any defects in the material or construction of the PV module.

Strings and Arrays

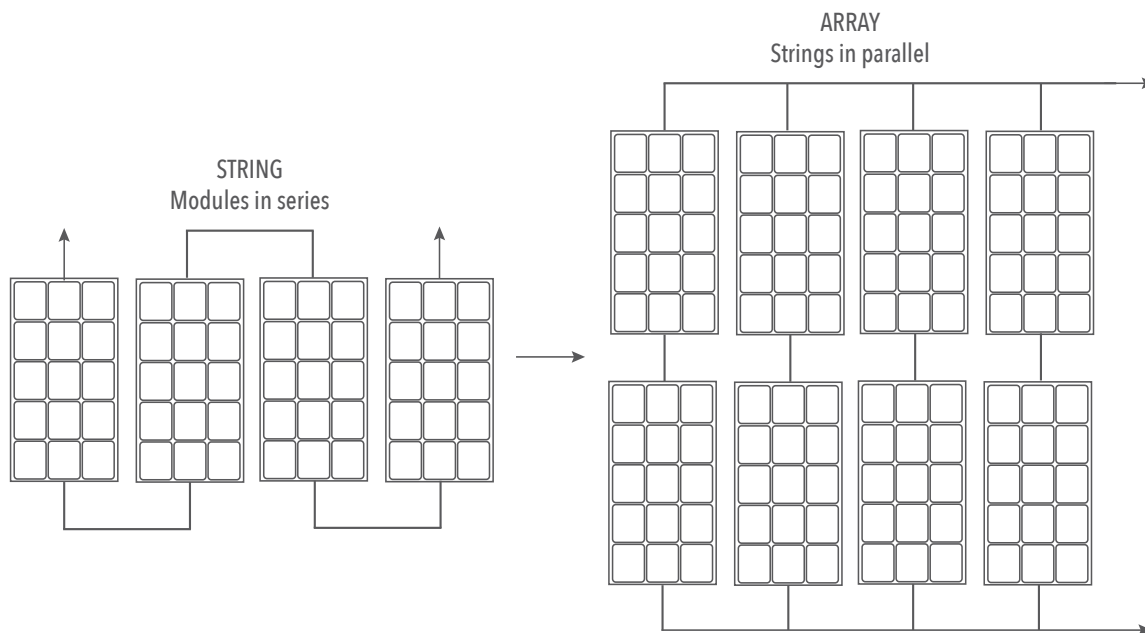

Figure 6: **Series and Parallel connection of PV Modules**

A number of PV modules connected in series is entitled a string. A string is designed such that it provides an output voltage in a range that is compatible with the solar inverter's input voltage range. Strings are then connected in parallel in a PV plant to accomplish the desired DC capacity. The maximum allowable

string voltage in India is 1000 VDC. When a number of strings are connected in parallel, it forms an array. Module in a string (i.e. in series) adds up the voltage, and modules in an array (i.e. in parallel) add up the current.

DC Cables



Figure 7: **DC Cables**

DC cables are used to carry DC current from the PV modules right up to the inverter. The DC cable should be sized to carry the required current (along with necessary safety margins) and also limit the voltage drop (i.e. resistance losses). Typically, single-core multi-stranded copper cables with cross section 4 or 6 mm² rated for a maximum voltage of 1.8 kVDC are used for string connections of PV modules up to the string junction box. It is a common practice to use red-colored sheath for positive terminal of the string and black-

colored sheath for negative terminal of the string. The DC cables used in solar strings use specialized connectors. As these connectors are usually installed outdoors, they should be IP67-rated, UV and fire-resistant with a typical operating temperature of -40°C to $+85^{\circ}\text{C}$. The contact resistance at the DC connectors should be minimal (typically less than $0.5\text{ m}\Omega$) rated for at least 30 ADC (but not less than the

short-circuit current expected through that connector with necessary safety factors) and 1,000 VDC. DC Cables from string junction box (see below) to inverter are typically longer. They are sized to carry the required current and also limit the voltage drop. As a general practice, the DC wiring should not cause more than 2 percent power loss in the PV system.

Strings Junction Box (SJB)



Figure 8: **Strings Junction (SJB)**

The String Junction Box (SJB) combines several DC strings in parallel. SJBs are also known as String Combiner Box (SCB) or Array Junction Box (AJB) or PV Generator Junction Box. SJBs should be weather resistant as they are normally installed outdoors. SJBs should contain fuses and surge protection devices (SPD) to protect the PV modules as well as inverters. If the inverter has sufficient number of DC input terminals along with surge arrestor and overcurrent protection capabilities, then the SJB itself can be completely evaded in the PV system.

DC Isolators



Figure 9: **DC Isolators**

DC Isolators are required to disconnect the PV modules and strings from the rest of the PV system in cases of faults, fire or repair. Most PV inverters already consist of a DC isolator, which should suffice. DC isolators are mandated globally; they should be clearly labeled and easily accessible.

Isolation Transformers (OPTIONAL)



Figure 10: **Isolation Transformer**

Isolation Transformers are used to safeguard the inverters from grid-side surges as well as to avoid any DC injection from the inverter into the grid. Many inverter models also have in-built isolation transformers. However, isolation transformers increase the cost and also decrease the efficiency of the system. Inverters available in the market today without such transformers have adequate protective components and hence, such transformers are now discretionary.

However, isolation transformers also serve another purpose, which may be more relevant

for certain grids or locations. If one regularly experiences lower voltages (especially at the tail ends of the grid) or higher voltages (especially near the substations), such voltages may not be a fault but still may cause the inverter to shut down. In such cases, an isolation transformer with a slight tap change to marginally increase or decrease the grid voltage for the inverter can be used. Isolation transformers are not required if the PV system is utilizing additional transformer such as a step-up transformer to step up the voltage to 11 kV.

Inverters

Inverters are among the most critical components of the PV system that not only perform power-related functions but are also responsible for the intelligence of the PV system. The major functions of the grid-

connected PV inverter are to:

- Extract maximum power from the PV modules (by optimizing the inverter's input impedance);
- Convert DC power into AC power;



Figure 11: **Inverter**

- Synchronize the output AC power with the phase, frequency, and voltage of the available grid in order to feed the PV power into the grid;
- Ensure anti-islanding by shutting itself down (and hence the PV generation) in case of grid failure;
- Ensure protection of the PV system from DC- side (i.e. PV-side) for reverse polarity, overcurrent, overvoltage and surge;
- Ensure protection of the PV system from AC- side (i.e. grid-side) for grid-fault (e.g. over/ under-voltage, over/ under frequency, high rate of change of frequency, etc.), ground fault, residual current or fault conditions, etc.

Inverters should be rated for appropriate Ingress Protection (IP). Single-phase string inverters, typically up to around 10 kW, give an output of 240 VAC, 1 ϕ , 50 Hz; while three phase string inverters give an output of 415 VAC, 3 ϕ , 50 Hz. It is also a general practice to use three numbers of single-phase inverters

to provide a net three-phase output. For larger rooftop PV systems, central inverters of capacities more than 100 kW are often used, in this case the output voltage is stepped up to 11 kV or above using step-up transformers. PV inverters have generally 96-98 percent efficiency.

- Solar Inverters are classified as below as per their application
 - Grid Connected Inverters
 - Stand Alone or Off Grid Inverters
 - Hybrid Inverters
- Grid connected Solar Inverters are further classified as below as per their rated capacity
 - Central Inverter
 - String Inverter
 - Micro Inverter
 - Power Optimizer

AC Distribution Box (ACDB)

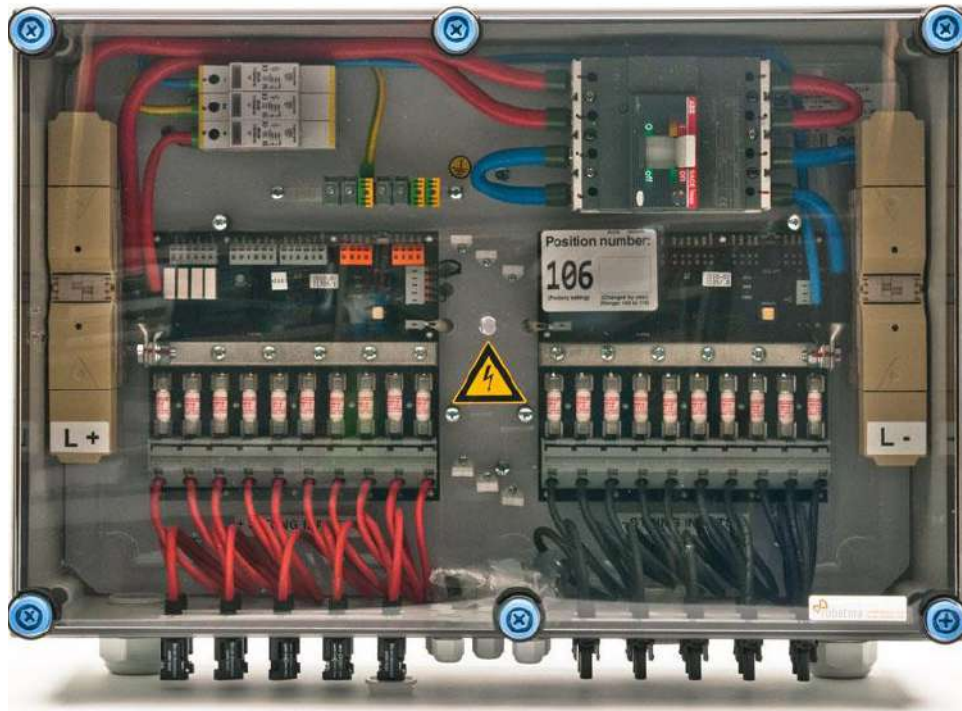

Figure 12: **AC Distribution Box**

ACDB should be placed close to the inverter immediately after the inverter (or the isolation transformer, if used). The primary function of the ACDB is to isolate the PV system (including PV modules and inverters) from the grid. Additionally, the ACDB

should contain Miniature Circuit Breakers to disconnect incoming and outgoing AC connections, Residual Current Circuit Breakers (RCCB) and SPD. [Note: RCCB and/or SPD may not be required if the inverter has these components.]

AC Cables

AC Cables carry the AC power of the PV system to the metering point, which is typically at the lower floors and hence has to be carefully chosen to ensure safety as well as to minimize power loss. While copper or aluminum cables can be used, it is highly recommended to use armored cables. AC cabling practices are common in India and suitable standards and certifications should be adhered to. As a common practice, AC wiring loss of a PV system should not exceed 2 percent.



Figure 13: **AC Cables**

Module Mounting Structures (MMS)



Figure 14: **Module Mounting Structures**

Module Mounting Structures (MMS) are used to secure the PV modules in particular orientation to collect maximum sunlight. MMS are designed keeping several structural considerations such as:

- Load (weight) of the PV system Load bearing capacity of the terrace, rooftop or the structure on which the PV system is mounted;
- Typical and maximum wind loads at that particular location, also factoring the height of the installation;
- Seismic zone safety factors;
- Other considerations such as saline or

corrosive environments; Most of the physical considerations are governed by Indian Standards. PV modules are often mounted at a tilt angle lower than the optimum angle for maximum energy generation. Lower tilt angles reduce the wind loads encountered by the PV system, resulting into a lighter MMS and also avoid the need to puncture a terrace, which may cause water seepage problems in the future. The mounting of PV modules should be optimized from a techno-commercial standpoint rather than just a technical performance standpoint.

Lightning Arrestors

While it is desired to protect all PV systems from lightning, Lightning Arrestors may not be mandated for PV systems with capacities less than 10 kW. It is highly recommended for PV systems to have dedicated lightning arrestors rather than depending on foreign rods and structures at greater heights that might exist at the time of installation.



Figure 15: **Lightning Arrestor**

Earth Pits



Figure 16: **Earth Pit**

Earth Pits used in solar PV systems are the same as conventional earth pits used for electrical installations and also follow the same standards. Each earthing system should have two earth pits, whether at the same end of the earthing system or each at the opposite end of the earthing system. This way, the risks from failure of the earthing system can be reduced and a lower earth resistance can be achieved.

Charge Controllers



Figure 17: **Charge Controller**

Charge controllers are typically used to regulate the charging of batteries in case of hybrid or off-grid systems. Charge Controllers perform the following specific functions:

- Extract maximum power from the PV modules either through advanced Maximum Power Point Tracking (MPPT) mechanism for larger PV Systems or through a simpler Pulse Width Modulation (PWM) mechanism for smaller PV systems.
- Regulate battery charging by controlling

the charging voltage and/ or current, and also protect the battery from discharging below the specified limit; and

- Provide a DC output at pre-specified voltage (e.g. 12/ 24/ 48V).

The DC output of a charge controller can either be used directly for DC equipment, or be connected to the input of a stand-alone inverter. A stand-alone inverter is simpler than a grid-connected or hybrid inverter, as it is not required to synchronize its AC output with the grid.

Batteries



Figure 18: **Battery**

Batteries are used in PV systems to store energy and utilize it when available solar power may not be enough to power the desired load. While lead acid batteries such as flooded electrolyte, gel electrolyte, Sealed Maintenance Free (SMF), etc. are commonly used due to lower cost and high availability, other batteries such as lithium ion are also

gaining popularity. Batteries are sized based on power and energy requirement of the load and are often oversized to provide autonomy during cloudy days. We scrutinize batteries not only in terms of energy density but also longevity, load characteristics, maintenance requirements, self-discharge and operational costs.

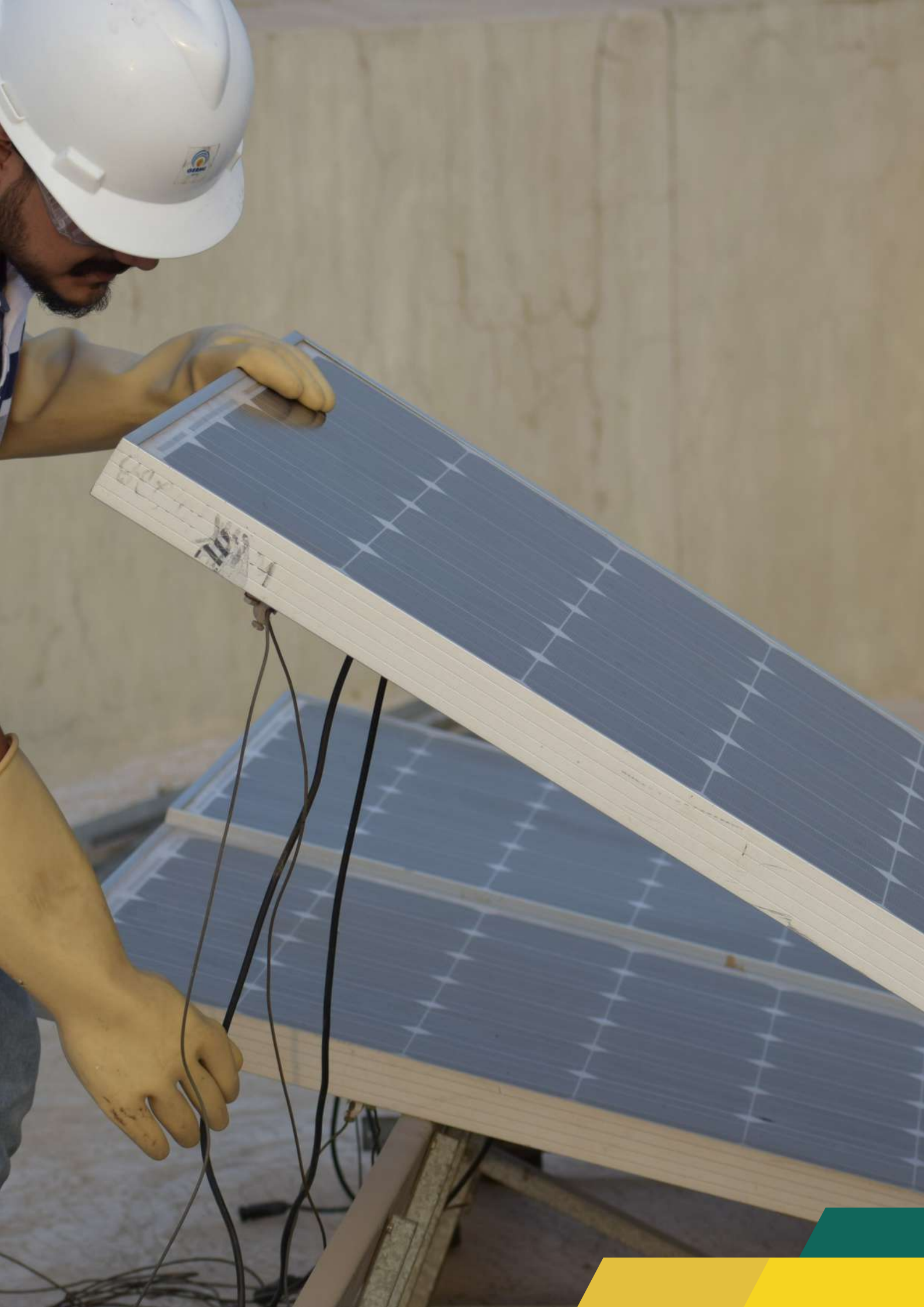

CHAPTER 3

Maintenance Categorization

Maintenance can be broadly classified into two main categories i.e. Scheduled Maintenance and Unscheduled Maintenance. The description of each categorization is detailed in this section.

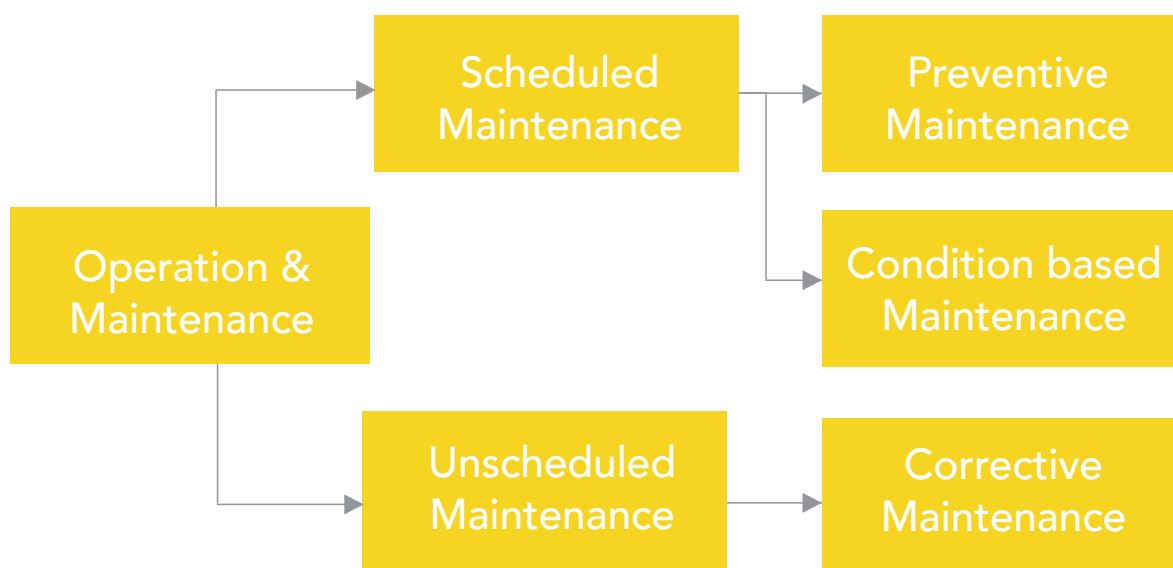

Figure 19: **O&M Approaches**

SCHEDULED MAINTENANCE

Scheduled maintenance (SM), as the name suggests is planned in advance and based on routine maintenance, repair and prevents faults from occurring. SM is done on a periodic basis. While performing maintenance, it is essential to refer to the component datasheet provided by the supplier so that one is properly familiar with

the component and safety measures, which must be followed while maintaining the component.

Under SM there are two general approaches to maintenance management:

- a) **Preventive Maintenance**
- b) **Condition based Maintenance**

Key features of Scheduled Maintenance

Regular intervals in accordance with the manufacturer's endorsements

Optimum balance is desired between the cost of SM and increase in the yield throughout the life of the system

SM is conducted during non-peak hours and preferably during night hours

a) Preventive Maintenance

Preventive Maintenance (PM) involves routine inspection, servicing and cleaning of modules at a scheduled interval of time. It is done in order to minimize downtime and unnecessary production losses. It improves performance, increases the availability and reduces the probability of the equipment failures. In preventive maintenance, a routine maintenance strategy is followed for plant inspection and is done during non-peak

hours so that the generation doesn't get affected. But it can also involve unnecessary site visits and higher maintenance costs.

The scheduling and frequency of PM are dictated by a number of factors such as environmental conditions, technology selected and warranty terms. Optimal equilibrium must be desired between the cost of scheduled maintenance and increased yield through the life of the system.

The main activities under PM include:

Mounting structure integrity

Module cleaning

Hotspots detection

Junction box servicing

Inverter servicing

Cabling connections

Balance of plant

Inverter Servicing

Earthing protection

Vegetation control

Recommendations:

- Cleaning time before 11 A.M. and after 5 P.M.
- Plant maintenance in night hours

NOTE:

The recommended format for preventive maintenance schedule, preventive maintenance report and generation report typically exists for most of the companies and the same should be followed. Additionally, details may also be sought as per the format given in Table [I, II and III].

b) Condition-based Maintenance

Condition-based maintenance implicates monitoring of equipment condition and plant operations on a real-time basis and addresses a potential problem at an early stage to prevent downtime. This approach uses periodic measurements to detect evidence that equipment is deteriorating, with the aim of extending service life by avoiding impending problems. It improves system performance and efficiency by anticipating failures and catching them early. This kind of maintenance requires a special diagnostic equipment and a robust plant performance monitoring system which can extend and improve system life.

UNSCHEDULED MAINTENANCE

Unscheduled maintenance addresses system and component failures after they have occurred. The key parameters are diagnosis, repair time and speed of response. Depending on the nature of fault an indicative response time may be within 48 hours. Under unscheduled maintenance there is one general approach to maintenance management:

Corrective Maintenance

Corrective maintenance includes repair of broken down equipment and is usually reactive. In short run, this saves staff time and expenses but over the long run, it can turn out to be costly in terms of unplanned equipment downtime, repairs, and shorter equipment life. It includes

- Tightening loose connections
- Replacing damaged modules
- Replacing blown fuses
- Repairing blown fuses
- Rectifying inverter faults
- Repairing equipment damaged by intruders
- Replacing blown connectors
- Rectifying SCADA faults
- Rectifying mounting structure faults

CHAPTER 4

Common Tools & Equipments Used

A person responsible for O&M of solar systems must be aware and equipped with tools and equipments. RTPV systems generally require special tools and these tools must be kept in a secured location and maintained properly. Therefore, it is important that all essential tools, spare parts and consumables are kept on site and ready for use. Measuring instrument must be checked regularly for its functionality and accuracy.

A list of such tools & equipment is enlisted below:

Safety:	First aid kit	PPE
Documentation:	O&M Manual	Datasheets
	System Service logbook	Paper & Pen/Pencil
Equipment	Digital Multimeter	Clamp Meter
	Hydrometer	Sun pathfinder
	Thermography Camera	IV - Tester
	Pyranometer	
	Battery maintenance kit	Battery water filler
Tools	Screw drivers	Nut drivers 1/4in & 5/16in
	Crimping tool set	Angle Finder
	Measuring Tape	Compass
	Cleaning Brush	Flashlight
	Hammer	Cutting Pliers
	Wire Stripper	Wire Cutter

EQUIPMENT



IV Tester



Thermography Camera



Clamp Meter



Pyranometer



Hydrometer



Multimeter

TOOLS

NOTE:

Before maintaining the system, the person should ensure:

- Conduct any output tests on a clear and sunny day;
- The inverter is turned off; and
- All circuit breakers and isolators are in OFF position.

TOOLS



Srew Drivers



Hammer



Measuring Tape



Megohm meter



Crimping Tool Set



Angle Finder



Battery Maintenance Kit



Compass



Wire Cutter



Nut Drivers



Flashlight



Cutting Piler



Wire Stripper



Cleaning Brush



Battery water filler

SAFETY TOOLS



Personal Protective Equipment (PPE)



First Aid Kit

TESTING METHODS & TECHNIQUES

Testing by using Multimeter

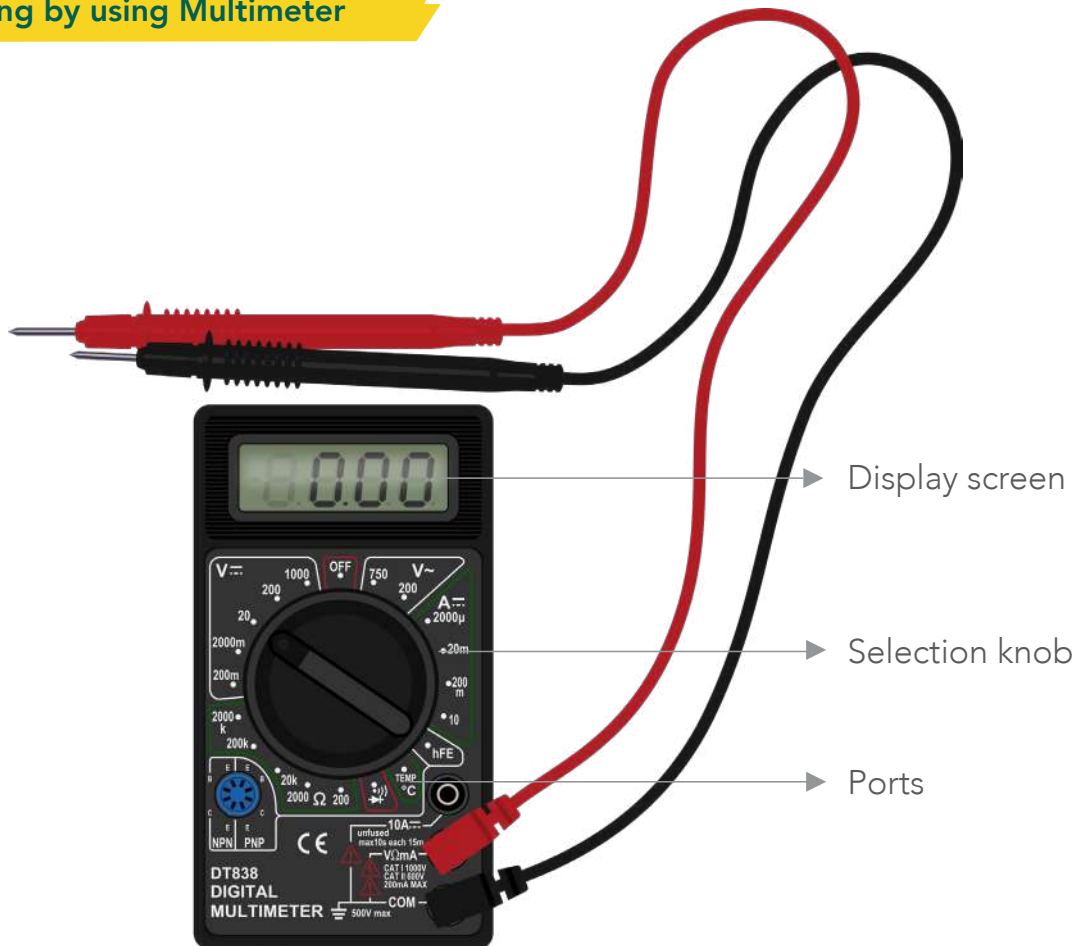

Figure 20: **Digital Multimeter**

A Digital Multimeter is a measuring instrument which can measure several parameters of an electric circuit. The standard measurements it performs are mentioned and described in this section.

The parts of the multimeter include:

- **Display screen:** The screen displays the numerical value of the parameter being measured.
- **Selection knob:** A multimeter performs many tasks like reading voltage, current and resistance. The selection knob allows the user to select the required task.
- **Port:** There are two ports on the front of the unit. One is the mAVΩ port which allows the measurement of all the three units: current up to 200 mA, voltage, and resistance. Various types of digital multimeter are commonly used to measure the output of the PV module and string as well as to test AC equipment such as inverters and other circuits.

Testing by using Clamp Meter



Figure 21: **Clamp Meter**

A clamp meter is an electrical testing tool that combines current sensor with a basic digital multimeter. The clamps measure current and the probes measure voltage. Having a hinged clamp jaw integrated into an electrical meter allows consumers to simply clamp around wires, cables and other conductors at any point in the electrical system and measure its

current, without disconnecting it. It measures AC & DC voltage, AC current, continuity, resistance, and with some models, DC current, temperature, capacitance, frequency and more. Typically, they measure to the nearest tenth of a unit making them perfect for electrical work.

Testing by using Infrared (IR) Camera

IR imaging pre-requisites (OPTIONAL)



Figure 22: **Thermography Camera**

IR imaging is done to determine the causes of power deficiency in several components of the PV plant. O&M personnel can use a number of diagnostic procedures. Thermal imaging of all the PV plant components like PV modules, array junction boxes, inverters, and cables is used to identify faults in the system that may not be visually identified.

- Before starting the IR scan, confirm that the PV array is operative and temperature differences in modules are not apparent when the system is inoperative.
- Before the test can be conducted ensure that the inverter is functioning.

IR camera settings

- Set the IR camera to “auto-scaling” rather than manual scaling. It will allow for the automatic adjustment of the temperature scale.
- Set emissivity¹ value to 0.95, usually the camera default value.

NOTE:

The IR camera does not capture shiny surfaces such as polished metals well due to their low emissivity value.

- Set temperature units to Celsius.
- Set color palette to Iron or Rainbow. The color palette displays hot spots as white and diminishing temperatures through red-orange-yellow-green-blue-indigo-violet-black.

Red indicates the hot condition and black indicates the cold condition.

IR inspection

Step 1: When solar modules are in operation in broad daylight and camera settings are properly adjusted, point the lens at the object of interest.

Step 2: For best results, position the camera as close to the module as possible without shading it or creating a reflection on the glass surface. While capturing images, it should be taken care that, shading of any part is to be avoided.

Step 3: Ensure that the picture is focused, either manually or automatically. If possible, the distance between the camera and the surface to be measured should not exceed 3 meters or 10 feet.

NOTE:

Some temperature differences will not be noticed if the camera is too far from the module.

Step 4: Hot spots will be easier to see if the image is taken perpendicular to the module surface. For best results, position the camera as perpendicular to the surface as possible.

NOTE:

Image quality will degrade at camera angles other than normal (i.e. perpendicular) incidence.

Step 5: If the temperature increases, it means that some hotspots have occurred.

Step 6: Record the module serial number, time, date, picture number.

Step 7: Record the module location in the array for all issues.

¹Emissivity describes how to quantify the efficiency of a surface for radiating energy in a defined waveband and at a given temperature

WORLD CLASS SOLAR PV MODULES

the
shining
star...

GOLDI
Poly PERC
Module (5 Bus Bar)



GOLDI
Light Weight
Module (5 Bus Bar)



GOLDI
ACPV
Module (5 Bus Bar)



*All new product certifications under progress.
Images depicted are for reference only.*

 www.goldigreen.in
 info@goldigreen.in
 **TOLL FREE NUMBER 1800 833 5511**



Mr. Bharat Bhut

DIRECTOR



About the Company: Goldi Green is a solar PV module manufacturing company, having an installed capacity of 500MW, manufacturing modules using Poly & Mono-crystalline solar cells in an ISO 9001:2015, ISO 14001:2015 & OHSAS 18001:2007 certified, fully automated and robotic, dust free facility.

Q Please share GOLDI GREEN's experience in solar PV sector so far?

A. Having commenced operations in 2012 with a 10MW facility, we expanded our capacity to 500MW in a course of 5 years. We owe this rapid progress to our principles of adhering to quality and adoption of best manufacturing practices, which has been a result of the rising demand for our PV modules across the globe. Having established ourselves as quality module suppliers, we have also begun undertaking EPC projects and have commissioned almost 20MW of projects in a very short period with many more important projects in the pipeline at present.

Besides, we have contributed to more than

1MW of residential roof top installations across the country.

We are a government recognized Star Export House and the first Indian company to be audited by SOLARBUYER, USA.

Q. How does GOLDI GREEN ensure quality in PV Modules?

A. Goldi Green PV modules are certified from TUV SAAR & UL India and manufactured in an ISO 9001:2015, ISO 14001:2015 & OHSAS 18001:2007 certified facility under stringent quality norms. Our modules offer up to +3% positive power output. We offer a 25 year output warranty and our modules are tested for PID resistance (IEC 62804),

salt mist corrosion resistance (IEC 61701), ammonia corrosion resistance (IEC 62716), and hail resistance as well as certified to withstand extreme weather conditions. Goldi Green modules undergo 100% EL inspection (Pre & post lamination).

Besides we conduct various in house reliability tests to assure the ruggedness and long term life of our modules.

Q. In a cost competitive market like India, what do you see as a next big breakthrough or innovation in Module technology?

A. Innovations in the solar industry vis-à-vis solar cell technology has seen major and rapid breakthroughs in the past two to three years, but when we look at the Indian market, taking into consideration the cost factor along with improved efficiencies and output, 1500 system voltage, Bi-facial modules with PERC technology and cut cell modules can create significant in-roads in this industry. Besides, frameless panels and clear panels will contribute to aesthetics in building design. But development and easy availability of BoS with respect to some of these new technologies is an important factor which cannot be ruled out.

Q. What should customers keep in mind while buying PV Modules?

A. Buying solar modules is not only an important decision with respect to money, but also with regard to a wise and long term investment. It is advisable for customers to keep in mind the following aspects when buying PV modules; Warranty: Customers are advised to carefully read the manufacturer warranty while making

their purchase. Performance warranty: Performance warranties, or power output warranties typically last for 25 years. We at Goldi Green provide performance warranty of 90% efficiency for 10 years and 80% efficiency for 25 years. Significant presence: Ensuring that the manufacturer has been around in the market for at least five years and is known for their quality rather than low price. A low priced product could be an attraction but in the long term will eventually prove to be a bad investment.

Q. How does a customer ensure that the modules last for 25 year? What are the best practices they should follow?

A. Caring for your solar plant will ensure hassle free performance for decades, saving on money and giving you best returns on your investment. Customers should follow these three simple steps:

1. Periodic cleaning of module surface with water.
2. Periodic inspection of modules and inverter.
3. Checking of AC & DC cabling, ensuring proper connection and rectifying any loose connections.

We were
130MW

GOLDI GREEN™
SOLAR PV MODULES & EPC

Now we are

**500
MW**

PV module mfg. facility



GOLDI GREEN TECHNOLOGIES PVT. LTD.

 www.goldigreen.in
 info@goldigreen.in
 +91 261 71 999 99
 TOLL FREE NUMBER **1800 833 5511**



UNIT 2

PHOTOVOLTAIC MODULES

WHAT WILL WE LEARN?

- Inspection and Fault identification
- Effect of dust accumulation, shading, module mismatch and physical integrity on PV module performance
- Maintenance & Troubleshooting methods which includes:
 - Basic level & Advanced level

CHAPTER 1

Inspection & Fault Identification

This chapter discusses the testing methods, O&M practices and common faults that occur in PV modules and related equipment that are required to perform O&M. This chapter also describes the correct and incorrect maintenance practices related to maintenance activities.

The performance of a PV System is highly affected due to the following reasons:

- Dust accumulation
- Module Shading
- Module Mismatch
- Physical Integrity

Dust accumulation

Solar panel cleaning is an essential practice in order to ensure that the performance of the PV system does not degenerate. Dirt build-up over the solar arrays can substantially affect the system performance, reduce the energy output, reduce any possible savings or revenue but more importantly reduce the life of the panels. It is essential to clean the modules regularly to prevent energy loss. Cleaned solar panels help to ensure that the system generates optimum electricity. Areas that are generally dusty and polluted will require frequent inspection and cleaning.

a) Dust observed on PV Modules?Figure 23: **Cleaned Modules**Figure 24: **Cleaning Required Shortly
(No significant financial impact)**Figure 25: **Cleaning required (Significant financial impact)**

With the passage of time, dirt accumulates on the surface of PV modules reducing the power output. Incorrect cleaning practices, bad quality water and use of inappropriate cleaning agent may damage modules and other array components and reduce system performance as well.

It is also essential to train the cleaning personnel on proper cleaning methods, safety measures and the use of appropriate cleaning tools.

b) Effect of Dust on PV Modules

Dust can substantially affect the electrical output from the system. The table below shows the impact of dust in the month of December on a 10 kW system located at the GERMI building in Gandhinagar, Gujarat.

NOTE:

The calculation is made by taking the energy output values before and after cleaning to show the exact impact of cleaning on PV modules.

*Rs. 5.14 is the Tariff Rate (per unit price)



PV Module	Actual Monthly Energy Generation
Uncleaned Modules 	1,143 kWh
Cleaned Modules 	1,443 kWh

Table 1: **Effect of dust on PV Modules**

Units Generated	1,143 Units (Uncleaned)	1,443 Units (Cleaned)
Units Gained = (1,443 – 1,143)	300 Units	
Monthly Savings = (300 × 5.14*)	Rs.1,620	
Daily Savings = (Rs 1,620 ÷ 30)	Rs.54 / day	
Annual Savings = (54 × 365)	Rs.19,500 /year	

Table 2: **Financial analysis of dust on PV Modules**

*Assumption: Rs. 5.14/kWh is the tariff rate of an average residential customer in India.

MODULE SHADING

PV systems generate electricity based on the amount of sunlight they receive, therefore when a shadow is cast on panels either by clouds, trees, building, vegetation, wires or any object that blocks the pathway of sunlight falling on PV modules, the power output decreases substantially. As a general rule, an array should be free of shade from

9:00 A.M. to 5:00 P.M.

Causes of Shading:

- Obstructions on the modules (clothes, objects for drying, etc.)
- Nearby obstructions like trees, poles, and buildings.
- Self-shading from adjacent rows.

a) Shading observed on PV Module?

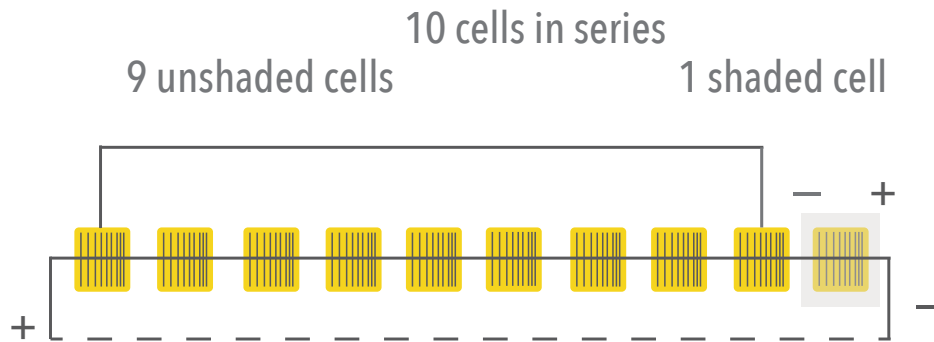

Figure 26: **Modules being used to dry chilies**



Figure 27: **Shading on PV modules due to surrounding objects**

b) Effect of Shading on PV Modules



If the terminals of the module are connected (module isc),
the power from the unshaded cells is dissipated across the
shaded cell.

Figure 28: **String of series connected solar cells having one shaded or mismatched cell**

Shading dramatically affects the solar PV array's performance. Even a small amount of shade on a few modules can significantly reduce the performance of an entire array. When a module or a part of it is being shaded, some of the cells become reverse biased acting as load instead of generators. If the system is not appropriately protected, hotspot problem can arise and the system can be irreversibly damaged. Shading, which causes loss of efficiency, can come in many forms. Depending on the object causing shading, it may be seasonal or for few hours each day resulting in fluctuations in the power. Due to partial shading on PV modules, the loss of energy generation is difficult to predict because it is dependent on several parameters; internal module-cell connections, module orientation, how modules are connected within an array and the configuration of inverter.

Hotspots

Hotspots occur when there is one low current solar cell in a string of several high short-circuit current solar cells, as shown in figure that follows. Under the short-circuit condition of the string, the shaded cell will become reverse biased. All the forward biased voltage of unshaded cell will appear across the shaded cell. This reverse bias could be very strong depending on the amount of partial or complete shadowing of the cell and the number of cells in series. Even if the shaded cell does not get damaged, it will result in generation of heat locally, as all the extra power generated in non-shaded cells is dissipated into the shaded cell. The dissipated power results in the heating of the shaded cell and nearby area, causing hotspots in the module. If the terminals of the module are connected (module isc), the power from the unshaded cells is dissipated across the shaded cell.

Power Loss due to shading



Figure 29: Shows the partial shading on a residential installation

The following example shows the effect of shading on power loss (see figure 29). The data is taken from 1.56 kW power plant. What is clear is that the loss in power output

is not directly correlated with the area of the module that is shadowed. Even a small shade can have a significant impact on the output of the module.



PV Module	% of Array Shaded	Power Loss due to Shade
Shaded Modules 	13%	44%
Unshaded Modules 	—	—

Figure 30: Power loss due to shading on modules

Daily Generation	4.2 Units (Shaded)	7.5 Units (Unshaded)
Units Gained = (7.5 – 4.2)	3.3 Units	
Daily Savings = (3.3 × 5.14*)	Rs.17 /day	
Monthly Savings = (Rs 17 × 30)	Rs.510 / month	
Annual Savings = (510 × 12)	~ Rs.6,100 /year	

Table 3: **Financial analysis of shading on PV Modules**

**Assumption: Rs. 5.14/kWh is the power tariff rate of an average residential customer.*

MODULE MISMATCH

Several solar cells, modules and arrays are connected in series and parallel in order to achieve high power output. In such a situation, all devices need to be identical in terms of electrical parameters. But usually, there are always some differences that can be significant. The differences could be due to the following:

- Mismatch from orientation, manufacturing differences, aging, string configuration or soiling (dust);
- Mismatch loss by using different module technology on the same string;
- Differences in the cell processing during manufacturing;
- Cells or modules of the same rating but different manufacturer;
- Cells or modules of the different rating but same manufacturer;
- Different environmental conditions, partial shading of cells or modules;
- Breaking of glass cover etc.

a) Mismatched Modules



Figure 31: **Two modules – one of mono-crystalline and the other polycrystalline technology installed in the same system**

b) Effect of Mismatched Modules

Mismatch faults in PV modules occur when the electrical parameters of one or group of cells are significantly changed from other. In addition, mismatch fault is caused by the interconnection of solar cells or modules that experience different environmental

conditions i.e. (irradiance or temperature) from one another. It leads to irreversible damage to PV modules and large power loss. However, they are difficult to detect using conventional protection devices, since they generally do not lead to large fault currents.

Typical Electrical Characteristics

Type		TITAN M6-60							
MaxPower@STC	Pmp (W)	220	225	230	235	240	245	250	
Power Tolerance	(W)		+0 to 4.9Wp or ±2.5%						
Max Power Voltage	Vmp(V)	28.80	29.19	29.61	30.02	30.23	30.40	30.72	
Max Power Current	Imp (A)	7.64	7.71	7.77	7.83	7.94	8.06	8.14	
Open Circuit Voltage	Voc (V)	36.42	36.78	37.08	37.32	37.56	37.68	37.80	
Short Circuit Current	Isc (A)	8.07	8.15	8.25	8.34	8.44	8.56	8.63	

Figure 32: **Datasheet of TITAN M6-60 PV Module**

Illustration

If one has placed a 220Wp and a 240Wp module together in one string with Isc 8.07A & 8.44A then the output will be 8.07

A. Therefore, the resultant current will be limited to the lower rating. This in turn would affect the performance and the overall plant output. (Refer datasheet given above)

PHYSICAL INTEGRITY

In order to identify the physical integrity of PV modules, visual checks need to be performed. The main problems that may be visually identified with minimum tools are moisture condensation within the PV modules, corrosion of contacts, delamination of cells and minute hairline cracks that may occur on the cells. Note that if even one the above problems occur, your PV module likely needs replacement.

a) Physical Integrity observed?



Figure 33: **Moisture Condensation**



Figure 34: **Tiny Hairline Cracks**



Figure 35: **Corrosion**



Figure 36: **Delamination**

b) Effect of Physical Integrity

During the process of manufacturing, cells may get hairline cracks which may have escaped detection during the time of testing. Post installation under operating conditions, these minor cracks widen and it becomes significant. Widening of cracks leads way to delamination and bubble formation due to vapor intrusion. This in turn affects the power output and the overall lifetime of the module. Due to continuous thermal stress cycle on solar cells, mechanical stress, humidity, UV light, physical and chemical stress the adhesion between the components of modules (glass, encapsulant, active layers and back layers) gets affected thereby

causing delamination of constituents. Due to lower interfacial strength, delamination mainly occurs at the interface of EVA and cells rather than the glass and EVA interface. Delamination near junction box likely causes the failure of connection to bypass diode resulting arcs at full voltage of the system.

- Degradation of anti-reflective coating takes place.
- Degradation of p-n Junctions takes place. As solar cells are semiconductors, they are doped for better conductivity. In this doping phenomenon, several p-n junctions are formed.

CHAPTER 2

Maintenance & Troubleshooting

BASIC LEVEL

Methods and Techniques for Cleaning PV Modules

Method A: Wet Cleaning

In this method of cleaning, water is used to eliminate dirt from the surface of the solar PV module. The cleaning process can either

be manual or automated. Manual cleaning is done by using a soft cloth, brush, detergent (non-abrasive) and clean water.



Figure 37: **Wet Cleaning (Manual)**

NOTE:

Before Cleaning

- Do not clean damaged panels. This can result in an electric shock. Thoroughly inspect the panels for any crack, damage, and loose connections.
- Cleaning Time: Low light conditions when production is lowest (Before 7:30 A.M. and after 6:00 P.M.) The best time to clean modules is from dusk to dawn when the plant is not in operation and risk of electric shock hazard is minimum.



Figure 38: **Damaged Module**



Figure 39: **Never climb on modules**



Figure 40: **Never sit or stand on PV modules**

Water Quality

- Preferable quality for cleaning the modules is de-ionized water. If de-ionized water is not available, rainwater or tap water can be used. Water from a domestic reverse osmosis (RO) plant may be used.
- The water must be free from sand and physical contaminants that could damage the module surface.
- Tap water must be of low mineral content with total hardness not more than 200 ppm.

Cleaning agent

- A mild, non-abrasive, non-caustic detergent with de-ionized water may be used.
- Abrasive cleaners or de-greasers should not be used.
- Acid or alkali detergent must not be used.

NOTE:

During Cleaning

- Ensure water used is free from dirt and physical contaminants. (De-ionized water is preferable). Water with mineral content more than 200 ppm should NOT be used. Cleaning agent must be mild, non-caustic and non-abrasive detergent may be used
- Do not brush or clean on the reverse side of the modules to avoid damage to the lead wires or the junction box.
- For removing stubborn marks of bird droppings, insects, dirt etc. make use of a soft sponge, fiber cloth or non-abrasive brush.
- Do not sit, stand or step on the modules for cleaning.
- Do not use a metal brush to clean solar panel surface.

Stubborn marks

- To remove dogged dirt such as grit, birds dropping, dead insects, tar etc., use a soft sponge, fiber cloth or non-abrasive brush.
- Rinse the module immediately with plenty of water.

Drying

- Modules should be dried after rinsing using a soft sponge or rubber wiper with a plastic frame on an extension pole.
- Wipe the module surface from top to bottom to remove any residual water from the module.

Water pressure

- Use of high pressure pipes for cleaning may exert excess pressure and damage the modules.
- Water pressure should not exceed 35 bar at the nozzle.

Water temperature

- The temperature of water used for cleaning should be same as the ambient temperature at the time of cleaning.
- Cleaning should be carried out when the modules are cool, in order to avoid thermal shock which can potentially cause cracks on the modules.

NOTE:

After Cleaning

- Check for any dirt accumulation at the edges of modules.
- Do not use corrosive chemicals or steam to speed up cleaning.



Figure 41: **Dirt Build-up due to wrong cleaning practices and Quality of water**

Method B: Dry or Brush Cleaning

If excessive soiling is present, then a brush, sponge or a cloth may be used. This could however lead to scratches on the module and must therefore be performed cautiously. Dirt

must not be rubbed vigorously or scraped, which can result in scratches on the surface of the PV module. The obvious advantage is that dry cleaning can save water requirements.



Figure 42: **Dry Cleaning Method (Manual)**

Water Requirements for a PV System

Water scarcity in India is a pertinent problem. There are many regions in India where, water is scarce. Council of Energy, Environment & Water (CEEW) estimates that water

requirement for O&M in India lies between 7,000 to 20,000 liters per MW, per wash which varies with the scale and location of the plant.

Rain Water Harvesting

In this technique rainwater is collected from the roof of a building and stored in a tank and then filtered by using a simple filtration technique, that can be used for cleaning of PV modules. In this way you can store water and can reduce the additional cost of water.



NOTE:

Rainwater falling on panels can be saved in a tank and then used for cleaning. This will minimize the cost of cleaning PV modules. A filter must be used to clean the stored water as the rainwater contains sand and other contaminating agents that may affect the PV modules.

Equipments Used



Figure 43: **Cleaning Equipment**

ADVANCED LEVEL

Methods and Techniques for Cleaning PV Modules

Method A: Wet Cleaning



Figure 44: **Wet cleaning using Robotic Method**

Automated cleaning is done using robotic systems and motorized cleaning tools which is an effective method for large power plants. However, such cleaning systems increase the overall system costs. The figure no. 44 and 45 show automatic wet cleaning robotic method and automated method.



Scan this QR code for a video demonstration



Figure 45: **Wet cleaning using an automated system**

Method B: Dry or Brush Cleaning



Figure 46: **Dry cleaning method using an automated system**

Dry or brush cleaning can also be done by robotic method which is shown in figure no. 46.

It saves considerable amount of water.



Scan this QR code for a video demonstration



METHODS AND TECHNIQUES FOR SHADING ANALYSIS

Shading analysis is usually carried out during the time of design of the rooftop solar PV plant. However, due to incorrect design or due to growth of trees, construction of nearby buildings, shadows may be created.

The size of the shadow of an object depends on:

- The size of the object
- Location of the object
- Date & Time

What to do when shading is observed?

Possible Solutions

- At the time of system installation, careful positioning of PV systems is the most obvious solution to handle the problem of shading. It is extremely important to consider all times of the day for all seasons of the year when working out whether a nearby object can cast a shadow on your system. Probability of nearby trees which may grow tall enough or buildings that may come up in future also needs to be considered before finalizing the location of PV systems.
- Visually inspect the PV modules. It must be noticed that there should not be any shading observed on PV modules. As a general rule, an array should be free of shade from 9:00 A.M. to 5:00 P.M. No object should be placed on modules that could shade the modules and adversely affect the performance.
- Perform a shadow analysis using the manual calculation method. This will help in estimating the generation loss. [Refer advanced section]
- One can analyze the annual data from morning to evening using the shadow analysis tool. [Refer advanced section]
- One can make use of the bypass diode to reduce the effect of shading on modules. With this technology, the shaded cells are simply bypassed and there is no effect the output of the entire panel. The power output of the panel might reduce, but will not be directly based on the power output of the lowest performing cell. [Refer advanced section]
- By making use of micro inverters. Micro inverters are attached to each and every solar panel and they convert DC electricity to AC, avoiding the effect of power losses from shaded panels, but micro inverters are not economically viable.

Case Study

Case1: Suppose a tree grows adjacent to your PV system and casts its shadow on the modules



Figure 47: **Tree grows adjacent to your PV system and casts its shadow on modules**

Possible Solutions:

- Visually inspect the PV modules
- Trim only those parts of the tree which are causing the shadow. It is NOT recommended to cut down the tree, for the purpose of installing a solar PV system is to offset carbon emissions. Cutting down a tree will undo any good that is done by installing a solar PV system.

Case 2: Suppose a nearby module casts a shadow on another module



Figure 48: **Nearby module casts a shadow on another module**

Possible Solutions:

- Visually inspect the PV modules. If you find that the module is shaded when the sun is overhead, then contact your system installer to correct what is an installation error.
- Alternatively, ask your installer to make use of extra bypass diode and blocking diode inside the junction box for protection against shading. [Refer advanced section]
- Make use of micro inverters (this will mean additional costs)

Case 3: Suppose a building gets constructed near your mounting structure



Figure 49: **Building gets constructed near your mounting structure**

Possible Solutions:

- Visually inspect the PV modules
- If you find that the module is shaded when the sun is overhead, then try shifting the modules slightly away (if possible).
- In the event that this is not possible, then contact your system installer and request to increase the bypass diode and blocking diode inside the junction box for protection against shading. [Refer Advanced Section]
- Make use of micro inverters.
- Contact EPC provider to shift mounting structure to some other location.

Case 4: Shading due to human activity and other obstructions



Figure 50: **Shading due to drying crops**

Possible Solutions:

- Visually inspect the PV modules.
- Shading due to nearby belongings; ensure that you do not place anything on the PV modules like red peppers or clothes etc. This is a problem in India where people love flat surfaces to dry food items and clothes.



Figure 51: **Shading due to nearby poles on terrace**



Figure 52: **Shading due to and human activity and other obstructions**

Methods & Techniques for Shading Analysis

Method A: Manual Calculation Method

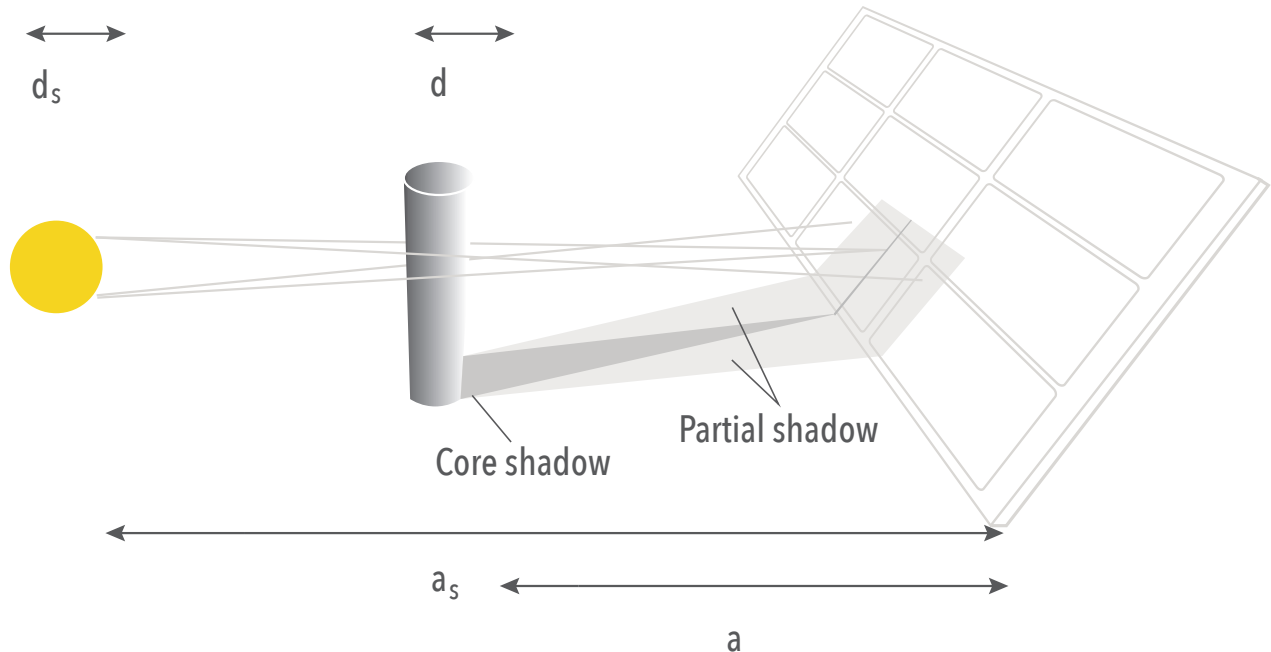

Figure 53: **Effect of core shadow and partial shadow on modules**

The Figure 53 shows the effect of core shadow (which is reflection is completely falling on modules) and partial shadow (whose reflection is partially falling on modules). Core shadow has greater shading effect than partial shadow.

The core shadow reduces energy incident on the cell by 60-80%

A partial shadow reduces energy incident on a cell by 30-40%

a_{opti} = Optimum distance of the object from PV module

d = Diameter of the object automated method.

$$a_{opti} = 108 * d$$

Method B: By making use of Shadow Analysis Tool

Shading is often a large problem during winter months when the sun's altitude is low and shadows are longer. For a location in northern hemisphere December 21 should be used for worst case shadow calculations. Solar Pathfinder is an instrument used to

analyze the shading effect of any object. The Solar Pathfinder has been the standard in the solar industry for solar site analysis for decades. Its panoramic reflection of the location instantly provides a full year of accurate solar/shade data.



Figure 54: Solar Pathfinder leveler adjustment

NOTE:

Solar Pathfinder is mainly used at the time of installation of the PV plant. But if around your rooftop, a tree grows nearby or any building is constructed, then you may need to find the shading effect of that object throughout the year on your generation then you can use the solar pathfinder for shading analysis.

STEP 1:

Adjust the leveler of solar path finder in the middle position, so the base gets leveled automated method.



Figure 55: Solar Pathfinder indicating latitude location

STEP 2:

Put the average sun path diagram of each month according to the latitude of the location.

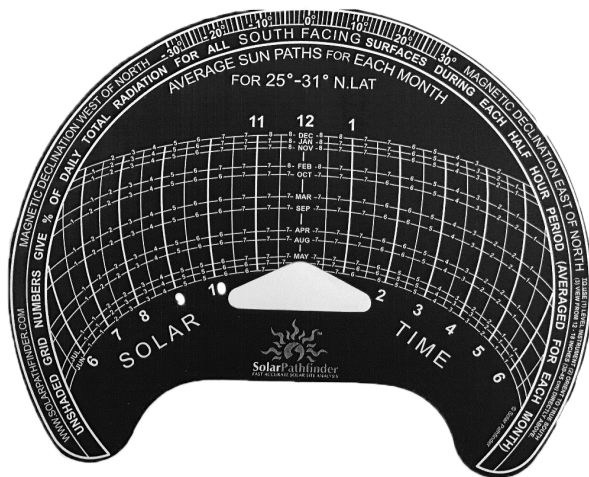

Figure 56: Solar Pathfinder arcs indicating time and months



Figure 57: Dome shaped cover of solar pathfinder for shadow analysis

STEP 3:

Put the dome shaped cover on the sun path finder and from there the shadow is to be analyzed. Use a pen to draw the shaded part. It will show the percentage of shadow free area available for a particular location throughout the year.

NOTE:

The average sun path for each month is available for all locations. You must be cautious in selecting for your specific location.

Method C: By making use of Bypass diode



Figure 58: **Location of Bypass Diode on PV Module**

Bypass diodes are essential to prevent the ill effects of shading. A bypass diode is used to avoid the destructive effect of hotspots or local heating in series connected cells.

Working of a bypass diode: In normal condition (no shading), the bypass diode is operated in reverse bias condition. However, if a series connected cell is shaded, reverse



Figure 59: **Bypass diode inside Junction Box**

bias will appear across it. Since the bypass diode is connected with opposite polarity, this reverse bias will act as a forward bias for the bypass diode. Thus, extra current which is generated by the non-shaded cells will be bypassed through the bypass diode, avoiding power dissipation in shaded cell and hence heat generation.

Circuit Theory

No cells shaded:

Current passes through all cells. No current passes through bypass diodes.

One cell shaded:

Current bypasses 24 - cell series string and passes through the bypass diode in parallel with that string.

One row of cells shaded:

Current bypasses three 24-cells series strings and passes through three bypass diodes.

One column of cells shaded:

Current bypasses the 24-cells series strings and passes through the bypass diodes in parallel with that string.

Entire module shaded:

Current bypasses all cells series and passes through three bypass diodes.

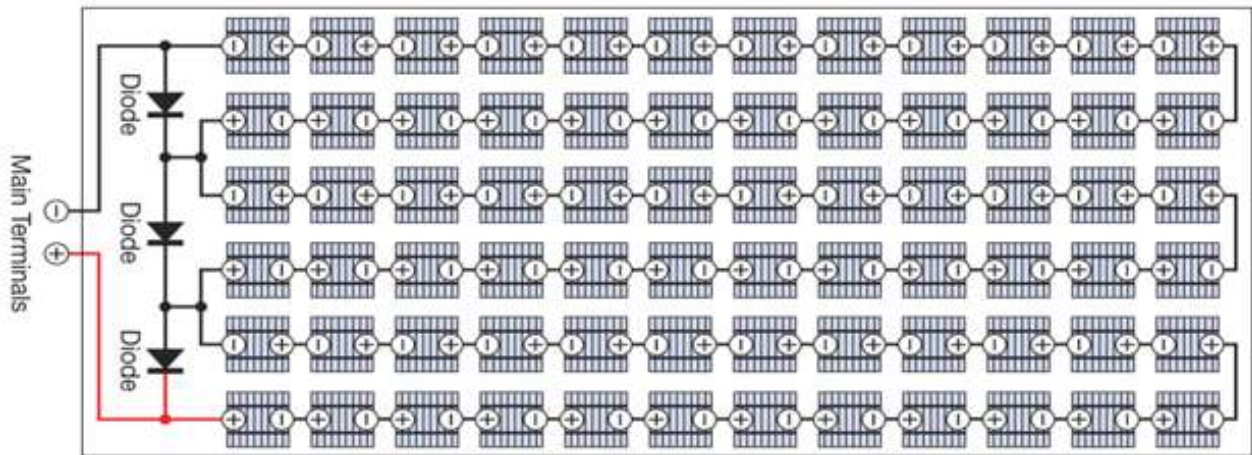

Above is the circuit theory which shows the functioning of bypass diode against shading.

Figure 60: **72-cell PV circuit - A bypass diode is typically installed in parallel with every 24 cell**

NOTE:

The main effect of a bypass diode is to decrease the open circuit voltage. The short circuit current remains same as that of an unshaded condition. Ideally, there should be one bypass diode connected across each cell in module, but in reality, there are only a few bypass diodes connected. This is done in order to reduce the cost. In practice, one bypass diode is connected across a series of cells in a PV module. It is recommended that there should be at least one bypass diode for every 10 to 15 cells to avoid the hotspots.

The average sun path for each month is available for all locations. You must be cautious in selecting for your specific location.

Check PV Modules Performance

A. By using Multimeter & Clamp on Meter

- Check the output voltage and current of each string of the array and compare it to the expected output under the existing conditions.
- Verify output from the array (I_{sc} and V_{oc}).
- Use a DC Clamp on meter to determine the array output current during sunny weather.
- Measure the open circuit voltage of the array as shown in the figure below and compare the measured amount of V_{oc} from the array with the manufacturer's specifications.
- Measure the short circuit current by putting clamps as shown in the figure below and set the meter to 10A range.

Voltage Measurement

Voltage measurement is done by connecting multimeter in parallel.

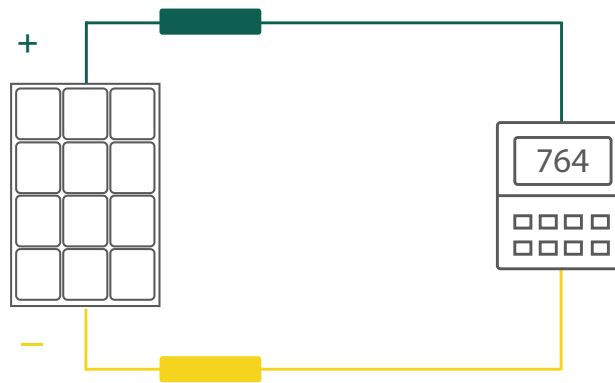

Figure 61: **Voltage measurement**

Current Measurement

Current measurement is done by connecting multimeter in series.



Figure 62: **Current measurement**

Analytical Data for Voc & Isc Testing

PV Module	Voltage(V)	Current(A)
Panel 1	20	15
Panel 2	20	15
Panel 3	20	15
Series Connection	60	15
Parallel Connection	20	45

Table 4: **Module voltage and current readings**

Date	25/3/2017
Time	3:00 pm
Open circuit Voltage	22.1 V (STC)
Short circuit Current	1.74 A (STC)
Module Temperature	50.6 °C
Irradiance on PV module	801 W/m ² (STC) 1000 W/m ²

Table 5: **Analytical data of a PV Module**

PV Module	Voltage(V)	Current(A)
Single Module	20.6	1.65
Two Modules in Parallel	20.6	3.30
Two Modules in Series	41.2	1.65

Table 6: **Voltage and Current readings of PV Modules connected in series and parallel**

The Table 6 shows the analytical data of a module to perform Voc string testing and Isc string testing. It can be noticed that as the number of modules connected in series is increased, the current remains constant. However, the voltage is increased in multiples of the number of modules connected in series. As the number of modules connected in parallel is increased, the voltage remains constant and the current is increased

in multiples of the number of modules connected in parallel.

Thus, one can obtain desired output by different connections of the solar PV modules as well as from various strings. If the irradiance observed is 801 W/m², then the voltage and current readings are satisfactory. Similarly, we can do the testing of entire string and measure the voltage and current respectively.

B. By using a Thermographic Camera

Thermography with the help of a Thermal Imager to help identify hot-spots within the module and other PV system componets.



- Check the physical condition of the PV array for any physical damage.
- Check using an IR Camera if there are any hotspots cells.

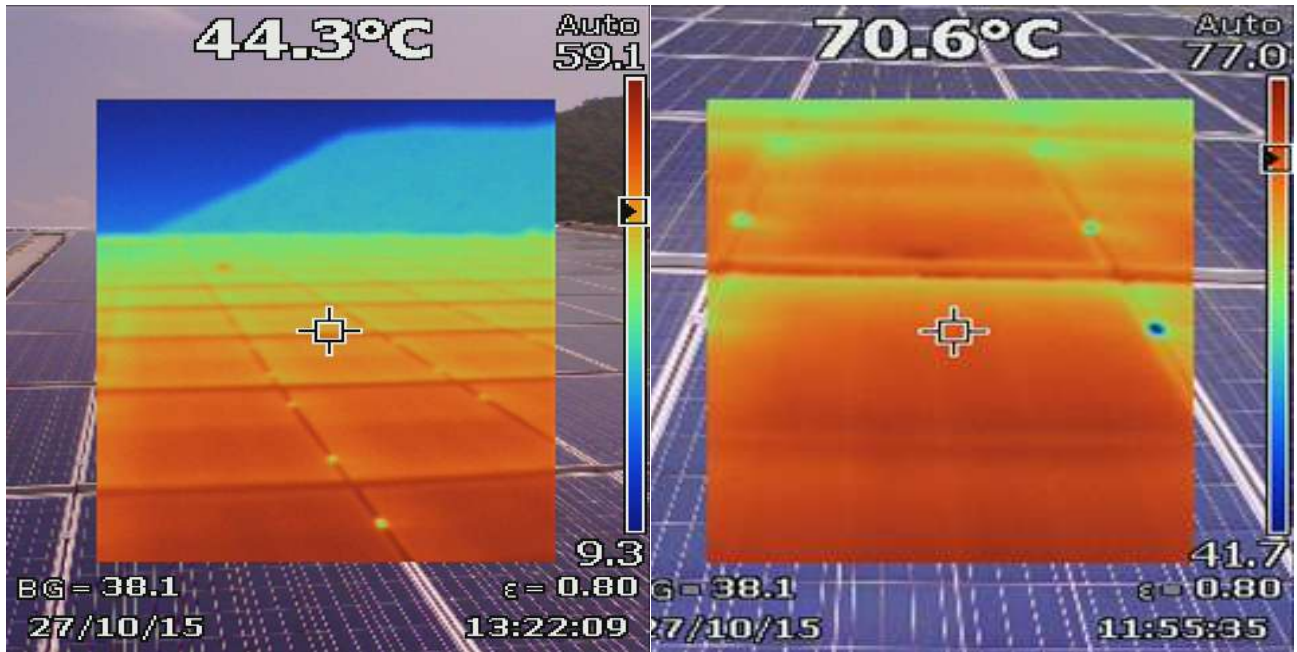

Figure 63: Thermography images under normal operation

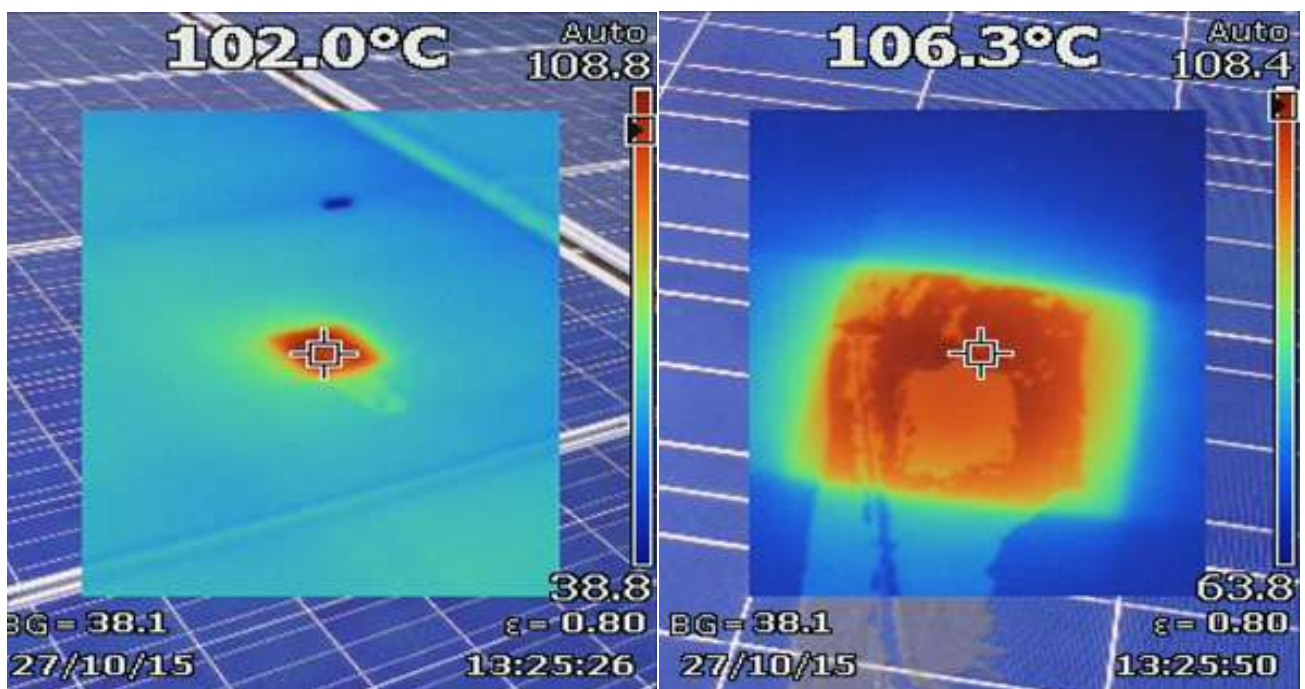

Figure 64: Thermography images showing unusual hotspots

In the first set of thermographic images, we observe a uniform module temperature between 40 degrees to 70 degrees. However, in the second set of images, we see that a particular cell is unusually heated

to a temperature of above 100 degrees. This indicates that one cell in the module is damaged and therefore the entire module needs to be replaced.



KEY POINTS TO REMEMBER

- Ensure that proper routine maintenance of PV modules is done and that modules as well as individual cells are checked periodically.
- Ensure that modules are cleaned regularly.
- Ensure that there is no shading on your PV modules, especially during peak sunlight hours. Prune any trees that might have overgrown. In case new buildings come up adjacent to your building, then consider changing the position of your PV array or elevating the installation using a superstructure if possible.
- During maintenance if you find the modules are mismatched, contact your installer to replace it. At the time of installation, ensure that your system installer does not use two modules of different specifications i.e. mismatched modules.
- If mismatch is observed, then replace the modules by contacting your supplier.
- Follow the maintenance schedule as listed in the table below. Note that this may vary according to your location and climatic conditions.

Maintenance Work	Frequency
Ensure that your system is protected from theft, children, animals	Daily
Ensure power generation	Daily
Inspect and clean PV modules from dust and other dirt	15 Days*
Check Whether all electrical connections are kept clean and tight	Half-Yearly
Check output voltage and current of each string of the array and compare it with the expected output under the existing conditions	Half-Yearly

Table 7: **Frequency of doing PV Modules maintenance work**

*It depends on how dusty your environment is. We suggest that you arrive at the optimum cleaning frequency by measuring data before and after cleaning and understanding your cleaning cycle.

PV without module-level monitoring is like a car without a dashboard



Higher system availability & lower O&M costs



The SolarEdge logo is displayed within a white circle that has a dotted border. The logo itself consists of the word "solar" in a black sans-serif font, followed by "edge" in a red sans-serif font with a white diagonal line through the letter 'e'.

solar**edge**

Mr. Shashidhara BV

Head of SolarEdge India

Having more than a decade's experience in the PV Industry in India, Shashidhara BV, is the Head of SolarEdge Technologies in India. With a career spanning 25 Years in Telecom, and Renewable energy, he has worked in the public sector, and in both national and international companies. From 2008, as Head of EPC Projects division, he was heavily involved in many large grid-connected PV projects in India. With global PV project experience and involvement in some of major Indian PV projects, he is well versed on industry standards and grid codes. Shashidhara BV is a rank holder in Bachelor of Electrical & Electronics Engineering from the University of Mysore (1992), India.

Q How can module-level monitoring troubleshooting make O&M activities more efficient?

A. Module-level monitoring provides pinpointed alerts, fault detection, and remote troubleshooting which can reduce both preventative and corrective maintenance. Intended to maintain the PV system at its highest working condition and limit system downtime, preventative maintenance can be completed more efficiently with module-level monitoring.

Corrective maintenance, conducted after an issue has been discovered and includes the actual repair process, can be significantly decreased with module-level monitoring as it can reduce trips to and time spent on PV sites. O&M service providers can perform many of the preventive and corrective maintenance activities from the comfort of an office via a smart phone, tablet or computer - decreasing the amount of long, expensive, trips to far-reaching sites.

Q. Can you give an example of how O&M can be more efficient with module-level monitoring?

A. If a module has decreased production, with module-level monitoring, an alert or mismatch report can help to notify the O&M provider, who can then review the power, current, voltage, and energy curves to analyze and identify the issue. For example, if the issue is a failed diode, power and voltage curves will provide a quick indication of the location and time of the diode failure. A screenshot from the monitoring platform can be provided to the module manufacturer for a warranty claim. During the next site visit, the O&M provider can replace the module, instead of only discovering the latent issue, thus avoiding multiple site visits and associated costs.

Q. Is there a way to decrease O&M costs during the initial system selection?

A. Selecting a system with module-level monitoring can lead to less trips to sites, less time spent onsite, and higher system uptime. Another important feature is the ability to remotely troubleshoot, analyze, and control inverter behavior, such as performing remote firmware upgrades or activation. It is also important to factor in future compatibility and warranty. A system using module-level power electronics has flexible design that can allow for different power classes and module brands to be used, this means that expensive module stocking is eliminated. Longer warranty periods and low-cost inverter replacements lead to decreased O&M.

Q. How important is inverter selection to long-term O&M?

A. The inverter manages 100% of system production and controls O&M. With O&M costs being approximately 1-2% of initial system cost annually, according to our estimates, module-level monitoring with remote troubleshooting reduces this cost by 15-25%. Some monitoring solutions have to be purchased separately and require annual fees, which can negatively impact system ROI, while others are free for 25 years. If the monitoring solution is included in the system cost, then a significant upfront cost is eliminated.

Q. How can you improve safety of O&M personnel during installation and maintenance of PV systems?

A. Safety during O&M activities can be improved both through training and with enhanced safety solutions. SolarEdge offers specialized training to EPCs, installers, and O&M service providers to help them become safer and more efficient technicians. In addition to training, safety can also be improved by using systems with enhanced safety mechanisms – such as module-level shutdown. Advanced inverter systems now come with embedded safety features, such as SolarEdge's SafeDC™ feature, that decreases voltage in DC wires whenever AC power or the inverter are turned off, in order to protect installers, maintenance personnel, firefighters, and assets.

Optimised Commercial System

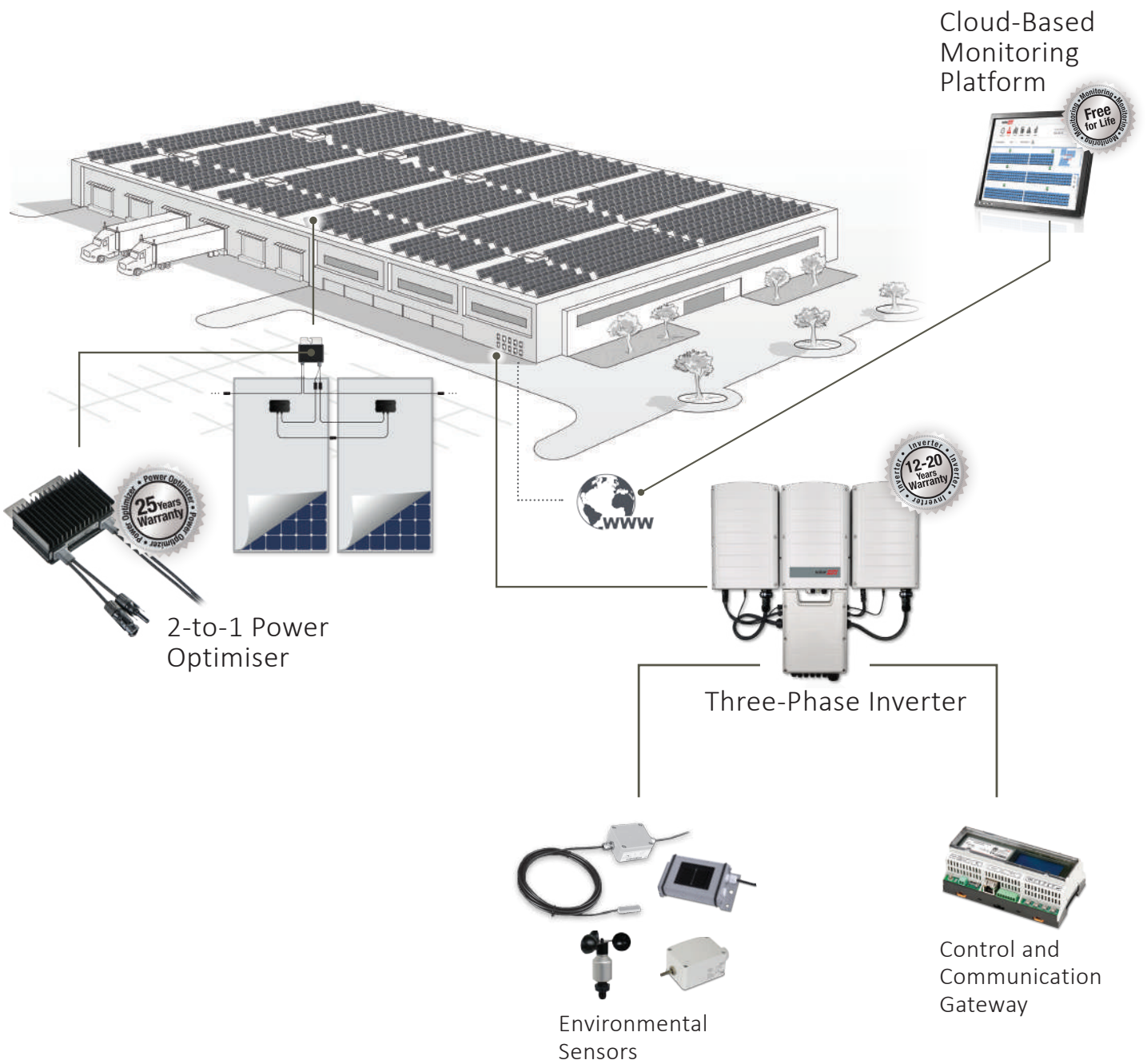



UNIT 3

INVERTERS

WHAT WILL WE LEARN?

- Inspection and Fault identification
- Maintenance & Troubleshooting methods which includes:
 - Basic level & Advanced level

CHAPTER 1

Inspection & Fault Identification

CLASSIFICATION OF SOLAR INVERTERS

a) Solar Inverters are classified as below as per their application:

Stand alone Inverter

A stand-alone inverter or off-grid inverter is designed for remote stand-alone application with battery backup where the inverter draws its DC power from batteries charged by the PV array and converts it to AC power. This is best suited for solar home systems, rural and village electrification applications where the utility grid is not available.

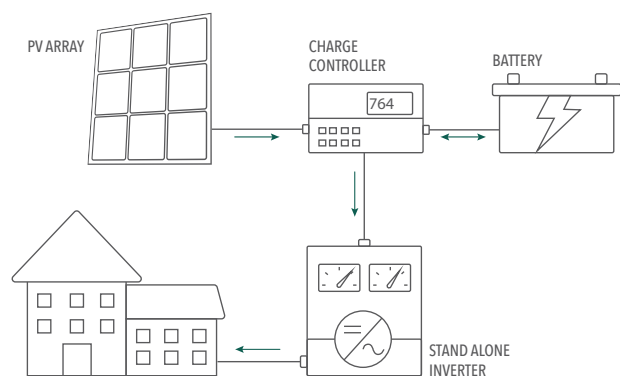

Figure 65: Standalone Inverter

Grid connected or grid tied inverter

Grid connected inverter or on-grid inverter is designed specifically for grid connected application that does not require battery backup system. It converts DC power produced by PV array to AC power to supply to electrical appliances and sell excess power back to utility grid. With a range of sizes available, to suit your needs, from small residential solar system to large commercial solar system.

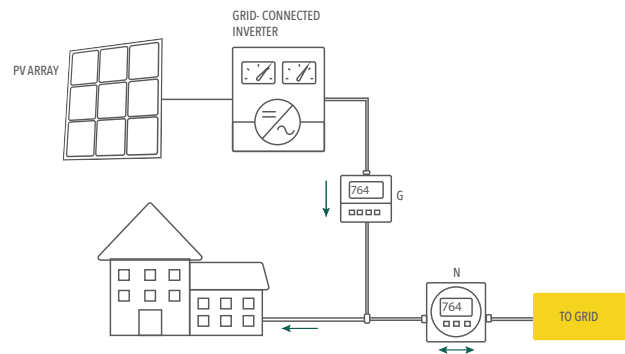

Figure 66: **Grid-Connected Inverter**

Grid interactive inverter

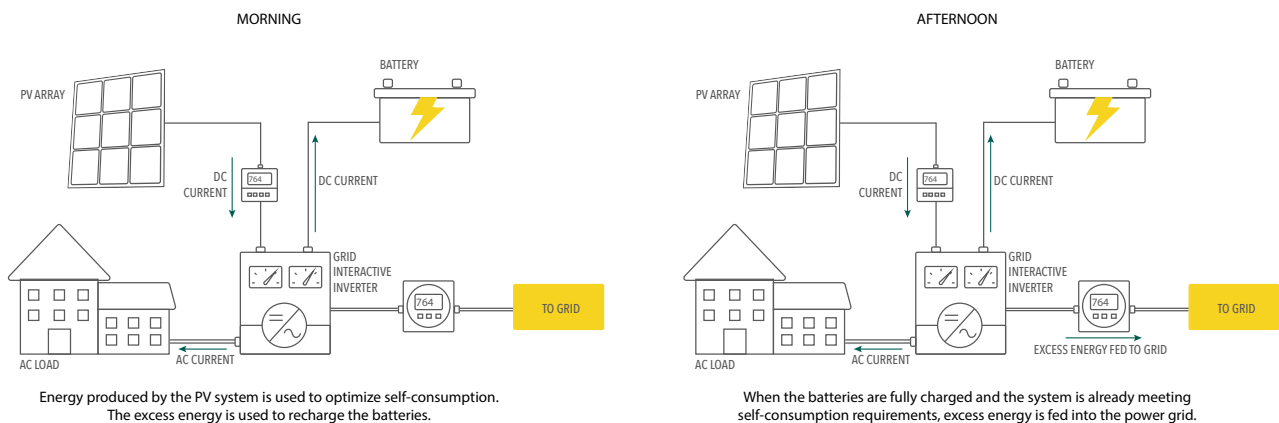

Figure 67: **Grid interactive inverter**

A grid interactive inverter is designed for residential, commercial and industrial applications. In a grid-interactive system, however, the inverter has multiple additional functions to perform. A grid interactive system provides reliable backup power in the event of a utility power failure. Under normal conditions, the inverter maintains the battery in a state of full charge in preparation for use during power outages. When the utility

power supply is ON, the inverter can operate as a grid-tied inverter, which converts DC power generated by the PV panels into AC power to cater to the load and feeds the excess energy back to utility grid line. When utility power is not available, the inverter can operate as backup power source to supply power from the PV panels and battery. The grid-interactive inverter steps in to invert DC power from both the solar and battery sources into usable AC power to run selected loads.

Hybrid inverter

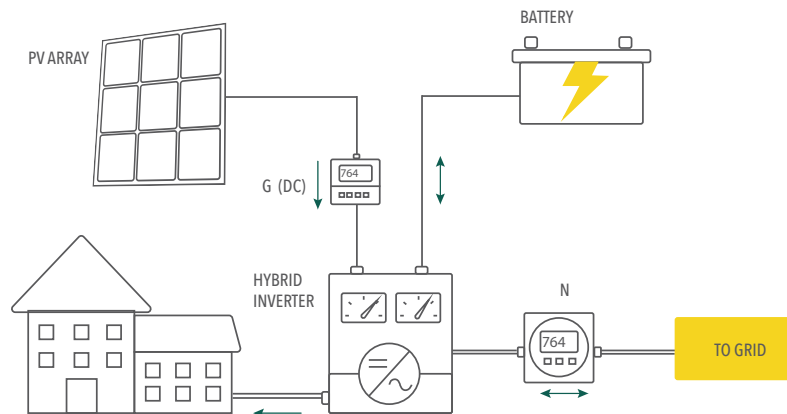

Figure 68: Hybrid Inverter

A hybrid inverter can function as either a stand-alone inverter or a grid tied inverter. It is connected to the battery bank, the utility grid lines, diesel generator (if present) and the loads within the building. A hybrid inverter is designed for hybrid power system that combines the solar array with the diesel generator and any other renewable energy

sources such as wind turbine generator, hydro generator, etc. It is generally used to provide continuous reliable power at remote locations for remote village electrification or remote island electrification. It can also be used in places where the grid is available but not reliable.

b) Grid connected Solar inverters are further classified as below as per their rated capacity

Central Inverter



Figure 69: Central inverter



Figure 70: Central inverter internal structure

When using a central inverter, the DC power produced from each string runs along wires to combiner boxes where they are connected in parallel with other strings. From the combiner box, the DC power is then directed

into the central inverter and converted to AC power. It is optimal for large systems where production is consistent across arrays. It requires fewer component connections.

String inverter

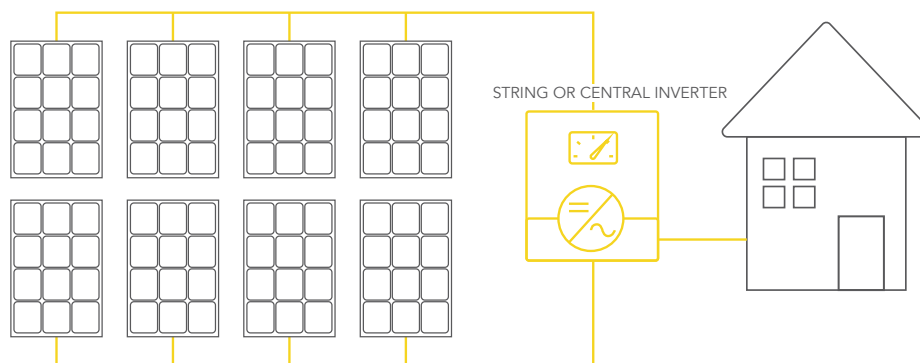

Figure 71: **String Inverter**

When using a central inverter, the DC power produced from each string runs along wires to combiner boxes where they are connected in parallel with other strings. From the combiner box, the DC power is then directed

into the central inverter and converted to AC power. It is optimal for large systems where production is consistent across arrays. It requires fewer component connections.

Microinverter

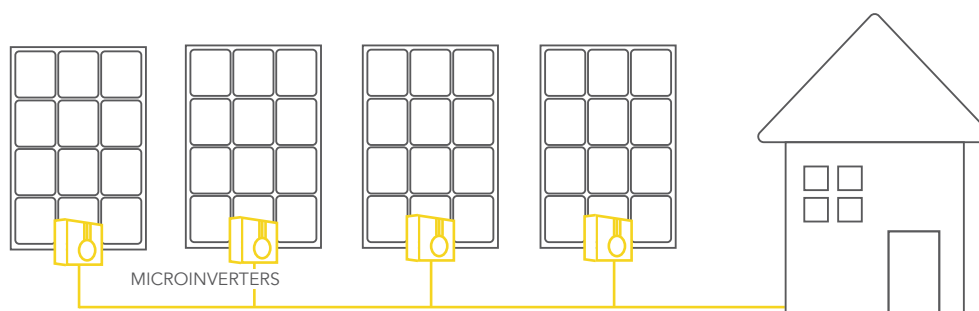

Figure 72: **Demonstration of Micro inverter**

A Microinverter converts direct current (DC) generated by a single solar module into alternating current (AC). Micro-inverters are installed on each individual panel in a solar energy system. The output from several Microinverters is combined and often fed to the electrical grid. Microinverters have several advantages over conventional inverters. The major advantage is that even the small amounts of module shading, or a complete

module failure, do not disproportionately reduce the output of the entire array. Because the DC-AC electricity conversion takes place at each panel, there is no "bottleneck" when one panel's production decreases. Micro-inverters allow you to monitor the performance of each individual solar panel. The primary disadvantage of a microinverter include a higher initial equipment cost per peak watt and increase in O&M cost.

Power optimizer

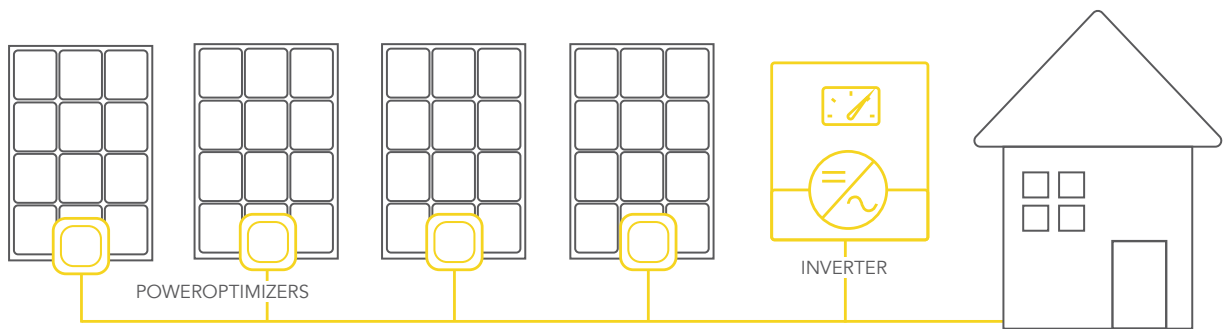

Figure 73: **Demonstration of Power optimizer**

The power optimizers are located at each individual panel similar to micro inverters. However, instead of converting the DC electricity to AC electricity at each individual panel, they condition the DC electricity and send it to a string inverter. A power optimizer is a DC to DC converter, replacing or in addition to the traditional solar junction box. The device may be connected by installers to each PV module or embedded by module manufacturers. Power optimizers allow flexible installation design with multiple

orientations, tilts and module types in the same string. It also increases energy output from PV systems by constantly tracking the maximum power point (MPPT) of each module individually. This approach results in higher system efficiency than a string inverter alone. Power optimizers reduce the impact of panel shading on system performance, and also monitors panel performance. Systems that use optimizers are typically more cost effective than those that use micro-inverters over the lifetime of the system.

ROUTINE INSPECTION

Inverters that are offline can have a significant adverse financial impact on the entire project. Inverter failure rates are important to financial metrics such as Return on Investment (ROI). More important is the ability of the service provider (or oneself) to quickly place the inverter back into service. The type of inverter fault often dictates how rapidly it can be placed back into service. This may include keeping critical parts that have long supply lead times so that the system is not left offline because of a lack of spare parts. This chapter describes various inverter fault identification & troubleshooting methods.



WARNING

- Before any maintenance, please switch off both the AC and DC power to avoid risk of electric shock.
- Wait at least 10 minutes to allow for a full discharge of the internal capacitors

Before:

- The inverter must be switched off before performing any maintenance.



Figure 74: **Switch off inverter before performing any maintenance**

During:

- Check inverter connections to make sure your system installer has done a good job:

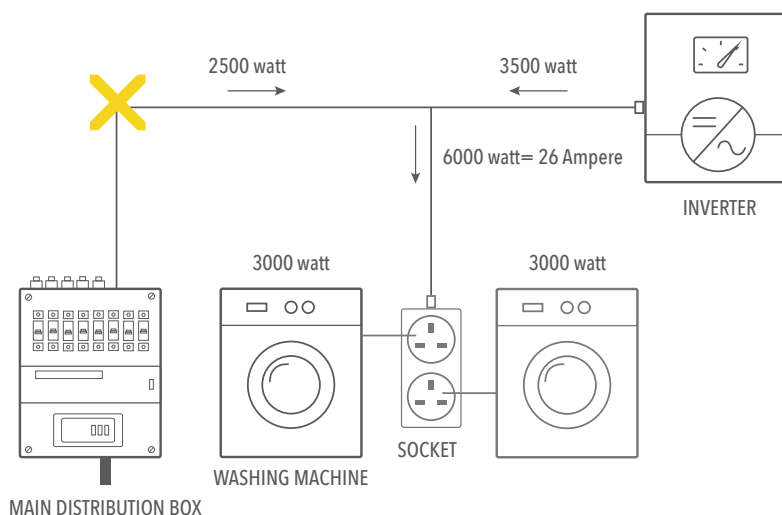

Figure 75: **Wrong connection from main distribution box at customer's residence**

Wrong connection: The AC output of solar grid inverter is connected directly to a nearby load point. Many installers directly connect the output of inverter to the load in order to save cable costs. However, this can be very harmful and can even damage the appliances.

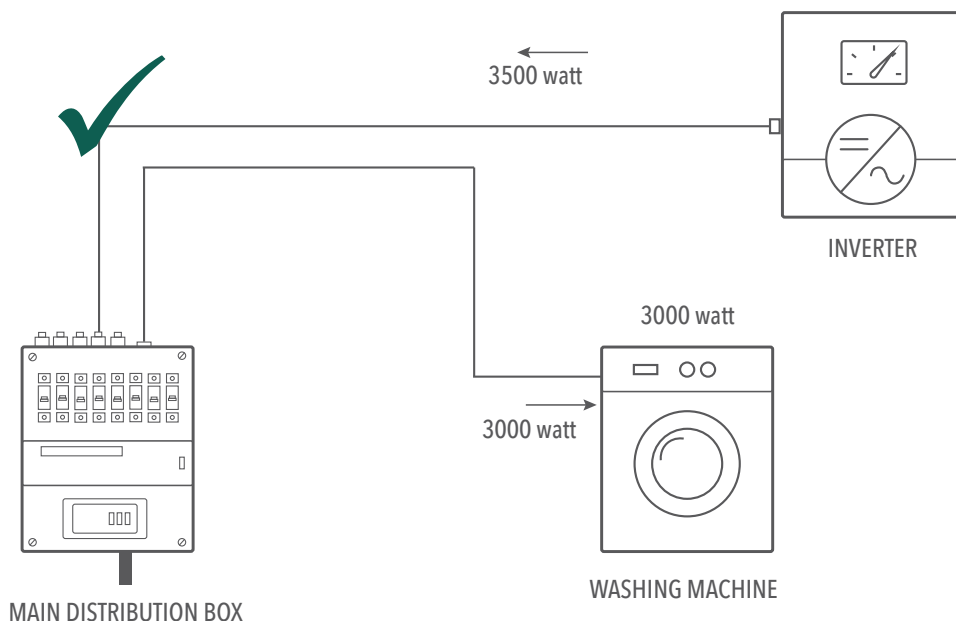

Figure 76: **Correct connection from main distribution box at customer’s residence**

Correct connection: The AC output of solar grid inverter connected to a dedicated module at the main distribution board and then connected to load.

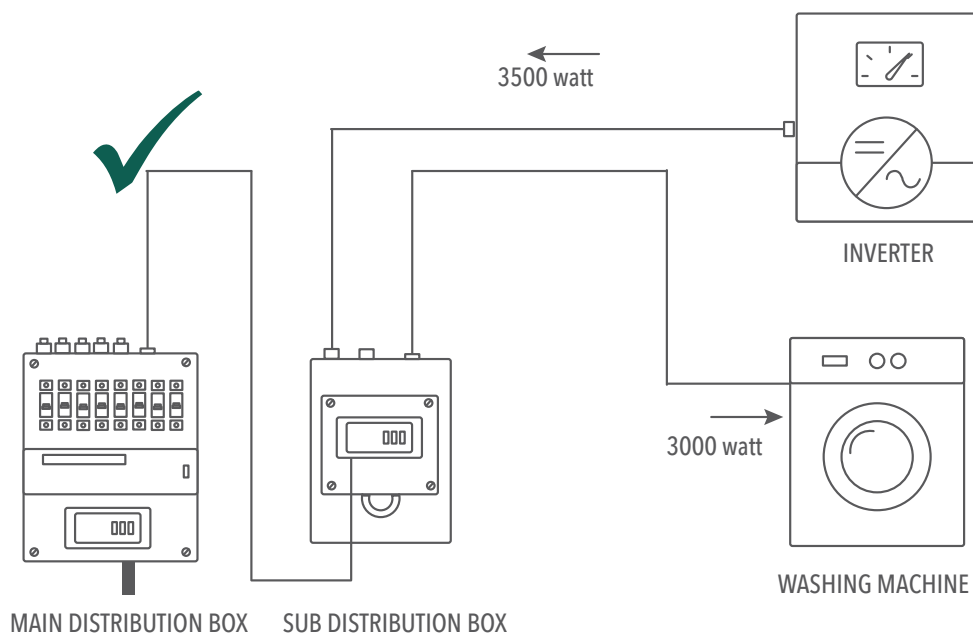

Figure 77: **Correct connection from main distribution box to sub distribution box at customer’s residence**

Correct connection: (AC output of solar grid inverter connected to a dedicated module of a sub-distribution board).



Figure 78: **Note readings from inverter display screen**

- Note the readings from inverter display screen.



Figure 79: **LED Green - Indicating correct operation of inverter**

- Check the inverter's display screen, which is the primary indicator of a possible problem with the inverter. The inverter can detect and display inverter warnings and faults.



Figure 80: **LED Red - Indicating incorrect operation of inverter**

- Visually check or inspect the inverter for external damage.

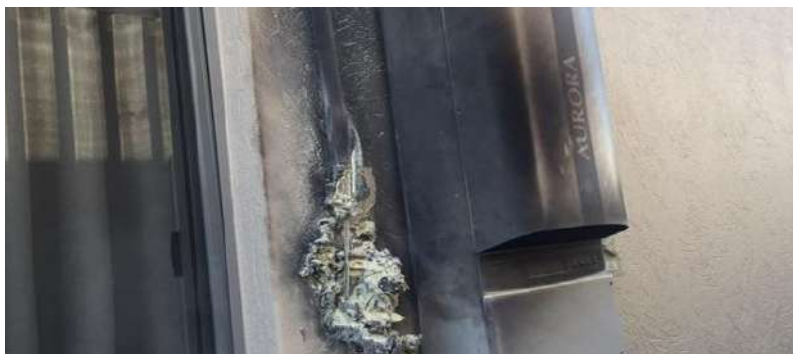

Figure 81: **Inverter damage - Burn out**



Figure 82: **Inverter base sealed properly**

- Clean area around inverter and verify that the base is sealed



Figure 83: **Disconnected wire from inverter base**

- Check for loose or disconnected wires



Figure 84: **Inverter installed without any shade or roof**

- Do not expose inverters to direct sunlight. For outdoor installations, use existing shadow or roof over the inverters.



Figure 85: **Inverter installed under shade**



Figure 86: **Inverter cables and conduits got loosed**

- Check the tightness of cable terminals, conduits, insulation, overheating and corrosion.



- Check to make sure that the inverter is well ventilated i.e. the exhaust fan is working properly. All inverters need good ventilation condition.
- Check if the inverter inlet and outlet fan is working properly. Vacuum or blow the inverter using an appropriate device. (By trained personnel only).



Figure 87: **Inverter ventilation room**



Figure 88: **Dust accumulation on Inverter**

- Check for noise levels of inverter through an audio check. If you notice that inverter is producing a large humming sound, then contact your service provider. Refer (Unit 3 Advanced Section).
- Inspect, clean or replace the filters (By trained personnel only).



Figure 89: **Cleaning inverter using blower**



Figure 90: **Check insulated gate bipolar transistors for discoloration**

- Check insulated gate bipolar transistors and inverter boards for discoloration. Check for input dc and output ac capacitors for signs of damage from overheating (By trained personnel only).

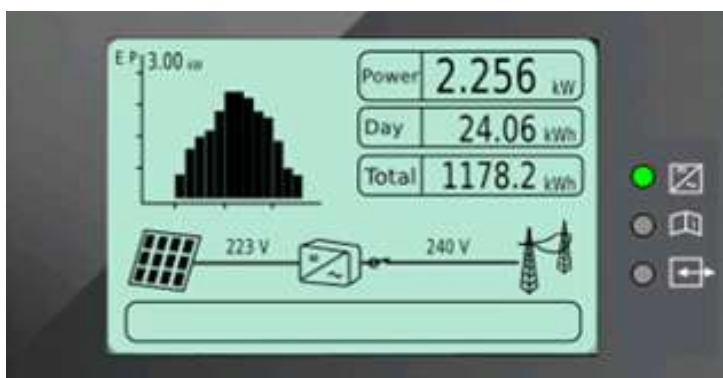

Figure 91: **Inverter display screen**

- Check inverter display and record all input and output voltages readings.

Use the inverter display to show the total energy generated in kilowatt hours (kWh). You can then write down this value and compare it to the one recorded during the last inspection. This should help you compare the inverter performance, provided the radiation conditions were somewhat similar.

If the inverter is not producing the correct output first use the 381's voltmeter and dc ammeter to check and record the inverter's operating dc input voltage and current level.

On the ac side, use the 381 clamp meter to measure the inverter's output voltage and current levels.

If the inverter is not producing the right amount of power there may be a number of problems, all of which can be easily checked with the 381 meter such as a blown fuse, tripped breaker, broken wires etc.



Figure 92: **Check inverter fuses**

- Check for fuse status both inside and outside inverter (By trained personnel only).



Figure 93: **Inverter grounding levels**

- Check for proper grounding levels of inverter



Figure 94: **Written inspection report of Inverter**

- Create a complete written inspection report

After:

If the visual inspection reveals potentially unsafe conditions such as a faulty internal circuit fault or a software fault, discontinue

the troubleshooting process and contact the inverter service provider.

CHAPTER 2

Maintenance & Troubleshooting

BASIC LEVEL

<p>Case 1: Inverter is not turning ON</p>		<p>Case 2: Output less than a comparable system in the same location</p>
<p>Case 3: Lack of power output compared to previous routine inspection</p>		<p>Case 4: No input voltage from solar PV array & no injection onto grid</p>

Case 1: Inverter is not turning ON

Possible Cause	Solution
Power switch is defective?	Take it to the service center for repair.
Inverter has tripped?	Press trip reset button on the inverter to reset it.
Battery terminals are loose?	Check battery terminals.
Battery terminals are corroded or rusty?	Clean battery terminals.
Battery is weak?	Charge it. If it is old, replace it.
Battery is discharged?	Charge it for several hours before putting it to work.
Battery is faulty?	Replace battery.
Battery terminals are reversed?	Connect terminals correctly. Refer to user's manual for details.

Case 2: Output less than a comparable system in the same location

Possible Cause	Solution
System is not optimally designed	Inverter and array are not well matched.
	OR High losses / voltage drop in the cables. Check calculations, possibly replace with larger cables.
Incorrect installation	OR Strings are not correctly wired, not plugged into connectors properly, loose connections, no voltage on terminals in PV array combiner box. Incorrect DC polarity in circuit. Check for all of these.
	OR Mismatch losses due to non-optimal design or installation. (Refer Unit 2.)
Modules not uniformly aligned (different tilts or orientation).	OR Remove cause of shade if possible. (Refer Unit 2.)
Array shading	OR Modules have a lower peak performance than guaranteed by the manufacturer. Test with IV tester required. If module performance is observed to be low then contact the module manufacturer for a replacement.
	OR Inverter overheating due to clogged vents or bad ventilation and is de-rating itself. <ul style="list-style-type: none"> • Check for any dust accumulation. (Refer Unit 2) • Clean inverter • Check proper wiring and insulation. (Refer Unit 4) • Check proper ventilation condition
If no clear indications are identified	OR Check for possible problems originating on the grid. Contact inverter manufacturer or utility.

Case3: Lack of power output from the previous routine inspection

Possible Cause	Solution
Total kilowatt hours (kWh) produced are less or the array current is lower as expected under high solar irradiance condition	Record the amount. If the inverter can display the total kilowatt hours (kWh) produced since it first started up, use this number to compare the PV system’s production since the last inspection. OR
PV modules shaded or dusty	Check if the array is shaded or if there is any dirt accumulation on it. Remove the source of shade or clean the modules. (Refer Unit 2) OR
Defect or fault in modules, junction box, wiring or caused by overheating, storms or lightning.	Check strings in PV array combiner box. Measure open circuit voltage (Voc) & short circuit current (Isc) by using digital multimeter. OR
	Disconnected terminals may be some loose or the connectors might be burned OR
	Defective bypass diodes or blocking diodes in individual modules caused by lightning, overvoltage or surge. Check the whole string. If the output is observed to be less than expected, Check the individual modules. OR
Blown fuse, a tripped breaker, or broken wires.	Use a voltmeter and multimeter to check and record the inverter’s operating input voltage and current level on the DC side. Similarly, check the voltage and current level on the AC side OR
AC overloading of the inverter	Load on the inverter might have too high of a current demand. In this case, you might need to reduce the loads or replace the inverter with one that has a larger output.

NOTE:



Take measurements in conditions of constant sunlight, not in variable conditions. Compare with measurements made with the previous inspection.

Case 4: No input voltage from the array & no injection onto grid

Possible Cause	Solution
Situation 1: No DC voltage at the inverter input	Too dark, not enough sunlight. Come back at a better time when there is enough sunlight.
	OR
	Main DC disconnect or isolator in open position. Check voltage at disconnect or isolator input. Defective disconnect or isolator.
	OR
Situation 2: There is a DC voltage at the inverter input but the inverter indicators are not showing anything	Excess voltage suppressor has short-circuited the array to earth. Check surge protection device.
	OR
	Open or short circuit in the array. Damaged cables or modules. Open PV array combiner box and test strings. Refer (Unit 2)
	OR
Situation 3: Inverter indicates DC input voltage during the day but nothing is being put onto the grid	Too dark, not enough light. Come back at a better time when there is enough sunlight.
	OR
	Utility grid black-out. The inverter should operate again when the grid comes back on.
	OR
Situation 3: Inverter indicates DC input voltage during the day but nothing is being put onto the grid	Blown fuses, activated circuit breakers and ground fault interrupters on the AC side between inverter and grid. Check the main utility fuse. Refer (Unit 4)
	OR
	Check any fault indicators. The inverter has detected a fault in the array and has shut down. Test strings individually in the PV array combiner box. Refer (Unit 3 advanced section) Possibly isolate the string that is causing the inverter to shut down by disconnecting one string at a time until string with fault is identified.
	OR
Situation 3: Inverter indicates DC input voltage during the day but nothing is being put onto the grid	The inverter has detected a grid fault or grid operating outside design parameters for the inverter causing the inverter to shut down. Check inverter indicators (faults/ warnings). Inverter should automatically start up again when problem clears. Contact utility if it is reoccurring frequently.

ADVANCED LEVEL

Alarm beeps or Noise

Fault description	Possible Cause	Solution
Alarm buzzer beeps continuously	Overload error?	Disconnect extra load.
 Scan QR Code to see how	Cooling fan is stuck?	Call or take the inverter to the service center.
	Too much of fan noise?	Clean the fan. Vacuum clean the inverter. Check for faulty fan. If problem persists, replace it or get it done by trained personnel.
Inverter making a humming noise.	Wind noise?	This is normal. No need of any action.
 Scan QR Code to see how	Humming noise produced by non-pure sine wave Inverter?	This is normal. No need of any action.
	Too much of fan noise?	Clean the fan. Vacuum clean the inverter. Check for faulty fan. If problem persists, replace it or get it done by trained personnel.

Power Output

Troubleshooting displayed warnings on Inverter screen

Warnings are displayed if a condition is detected that does not require the inverter to shut down but may require attention. The following screen is a sample of a warning message. These messages differ from inverter to inverter. Make sure to check your manual for the exact description of the error.



FAN WARNING

System Warning

The following table lists some of the common system warnings.

Warnings	
Fan Warning	Contact Service Provider
Magnetics high temperature warning	
Heat sink, temperature warning	
GFDI current warning	
AC surge warning	
DC surge warning	
Negative DC current warning	

Troubleshooting displayed Fault Errors in Inverter Screen

If a fault condition has occurred, the inverter will stop power production until the fault is cleared. A fault may be a latching or non-latching fault.

Non-latching: Automatically clears if the fault condition is resolved and the inverter automatically restarts after completing its startup sequence.

Latching: Requires manual intervention to restart the inverter. If the inverter has faulted, the display screen will show the corresponding fault information in a series of three or more screens. The display will then cycle back through the three different messages.

- Displays the fault category followed by the hexadecimal fault code(s) value.

Fault
AC FAST UNDERVOLT A GFDI FAULT

- Displays a text description of the fault code(s).

Fault Codes SYS 0020 GRD 0000

- Displays Service Provider Technical Support contact information

COMPANY NAME
Phone: 123475978
email:inverter@support.com

Read the respective inverter user manual for various LED indications on the panel and the inverter error codes. Some of which are listed below:

- Grid under voltage
- Grid over voltage
- Faulty phase sequence
- Over load
- Short circuit
- Battery under voltage
- Battery over voltage
- Earthing fault

Question: Is your inverter displaying a Ground Fault Error?

Solution: Ground Faults are difficult to troubleshoot. To identify the cause of a ground fault, the following steps can be taken:

Possible Cause	Solution
Fuse blown	Turn inverter off; Turn off the dc and ac disconnects; Open the control electronics box and locate the GFDI fuse on the backplane. If the fuse is blown, a ground fault exists outside the inverter.
	OR
	Remove the GFDI fuse.
	Check for continuity (in ohms) across the GFDI fuse using ohmmeter. If the meter indicates no continuity then a ground fault likely exists.
	Check the DC voltage between the earth ground and the grounded terminal of the Check the array wiring. For the best results, perform this test with the DC disconnect in both the ON and OFF positions NOTE: The grounded leg of the solar array is not disconnected inside the DC disconnect box.
	Once the ground fault condition has been eliminated, check the voltage between earth ground and the grounded side of the PV array.
Inverter shutdown	Ensure the DC disconnect is in the OFF position and install the new GFDI fuse.
	Restart the inverter.
	With the power off before starting the inverter again, check for any ground faults.
	The electric utility's voltage and frequency are sensed by the inverter, which normally generates AC electricity at the same voltage and frequency.
	The AC current output from the inverter fluctuates with the level of solar input on the array.
Inverter trips	Low or high electric utility voltage sensed by the internal disconnects will cause the inverter to shut down.
	If this problem exists, then contact the electric utility to correct the problem.
	Inverter problems could also be caused if there is any problem on the array side of the inverter, which trips one of the internal disconnects.

Warning



Verify that no shock hazard exists between both fuse terminals and earth ground before removing/replacing the fuse

Question: Is your inverter displaying Load Problem Error?

Solution: To identify the cause of a load problem following steps can be taken:

Possible Cause	Solution
Inverter sleeps or shutdown	First, check all load switches. Are they turned off or placed in the wrong position?
	Check to make sure that the load is plugged in. If not=>
Blown fuses or tripped breakers	Check the fuses and circuit breakers.
	If there are blown fuses or tripped breakers, locate the cause and fix or replace the faulty component. If not=>
Load is a motor	An internal thermal breaker might have tripped, or there might be an open circuit in the motor.
	In this case, plug in another load, and note its operation. If not=>

Question: Is your inverter displaying AC under voltage or over voltage fault?

Solution: To identify the cause of an AC Under voltage fault following steps can be taken:

Possible Cause	Solution
AC under voltage fault	Check the main branch circuit breakers. All breakers must be on.
	Check ac voltage with voltmeter. If it is not found within range, contact utility. If not=>
AC over voltage fault	Perform a manual restart
	Perform a manual restart
	Check power supply (ON/OFF)

Question: Is your inverter displaying Software fault?

Solution: Contact service provider or replace inverter if necessary.

(c) Tools required for inverter repair

Sl.no	Tools/Equipment's
1	Screw driver set with insulated handle
2	Ohmmeter
3	Replacement Fuses
4	Megohmmeter
5	PPE
6	Spanner set with insulated handle
7	Tester for grid voltage
8	Multi meter (voltage and continuity testing) 1,000V DCV range
9	Clamp meter (current measurement)
10	Wire cutter
11	Wire stripper
12	Small torch
13	Cutting plier
14	Cleaning / dusting cloth
15	Electricity safety gloves
16	Hydrometer (for Batteries)
17	Hammer



KEY POINTS TO REMEMBER

1. Place the inverter in a location that has good ventilation.
2. Ensure that direct sunlight does not fall on the inverter
3. Inspect, clean or replace the filters as needed
4. Check for loose or disconnected wires.
5. Check if inverter inlet and outlet fan are working properly or not
6. Check insulated gate bipolar transistors and inverter boards for discoloration.
7. Check for input dc and output ac capacitors for signs of damage from overheating.
8. Check for proper grounding levels
9. Create a complete written inspection report
10. The ground fault fuse and even the ac fuses must be kept in spare

NOTE:

- Having qualified experts available and properly equipped with common spare parts helps to maximize system generation.
- To avoid any generation loss. The inverter service is mainly done before 9:00 A.M and after 7:00 P.M. as the inverter needs to be shut down for certain time interval for maintenance activity.



UNIT 4

BALANCE OF SYSTEMS

WHAT WILL WE LEARN?

- Inspection and Fault identification
- Maintenance & Troubleshooting methods which includes:
 - Basic level & Advanced level

CHAPTER 1

Inspection & Fault Identification

CABLES

Cables play a very important role in system designing and array layout configurations of a solar power plant. Cables should be planned in a way that they can last for 25 years. Cables are generally placed directly under the ground or in ducts of the underground distribution system. This is one of the reasons, there being no major faults in the underground cables. However, if a fault does occur, it is difficult to locate and repair because these conductors are not visible. Following are the faults most likely to occur in underground cables:

- Open-circuit fault
- Short-circuit fault
- Earth fault

Open-circuit fault

When there is a break in the conductor of a cable, it is termed as an open circuit fault. The open-circuit fault can be examined by using megger. For this, the conductors of the 3-core cable at the far end are shorted and earthed, then resistance between each conductor and earth is measured by using megger. If the conductor is not broken, the megger will indicate zero resistance in the circuit. However, if the conductor is broken, the megger will indicate infinite resistance in its circuit due to circuit break.

Short-circuit fault

When two conductors of a multi-core cable come in electrical contact with each other due to insulation failure, it is termed as a short-circuit fault. Here the two terminals of the megger are connected to any two conductors. If short circuit fault exists between conductors, the megger indicates a zero reading. The same should be repeated for other conductors by taking two of them at a time.

Earth fault

When the conductor of a cable comes in contact with earth, it is termed as an earth fault or ground fault. To identify this fault, one terminal of the megger is connected to the conductor and the other terminal is connected to the earth. If the conductor is earthed, the megger indicates a zero reading. A similar procedure should be repeated for other conductors of the cable.

PROTECTION DEVICES



Figure 95: **Overcurrent protection devices (OCPDs)**

- The requirements for overcurrent protection in PV systems can be complex. To know whether an overcurrent protection device is required or not is crucial for both safety and performance. In case of an emergency or other need to shutdown, such as maintenance, disconnect switches are used to easily

open-circuit ungrounded, current-carrying conductors.

- Disconnects are required for the entire PV systems and also for individual components such as inverters, panels etc., so that they can be safely isolated from all power sources, maintenance and repairs.
- Disconnecting a piece of equipment means switching "OFF" the ungrounded conductor of circuit (creating an open circuit), thus stopping the flow of current and removing the voltage potential
- Overcurrent protection devices (OCPDs) protect the conductors connected to them by preventing current levels in the circuit that exceeds the ampacity rating of the conductors. Fuses and circuit breakers are examples of overcurrent devices; they are rated in amps and if the rating exceeds for a specific duration of time, the fuse will blow or the breaker will trip.
- This opens the circuit and stops the flow of current before the conductor is damaged.

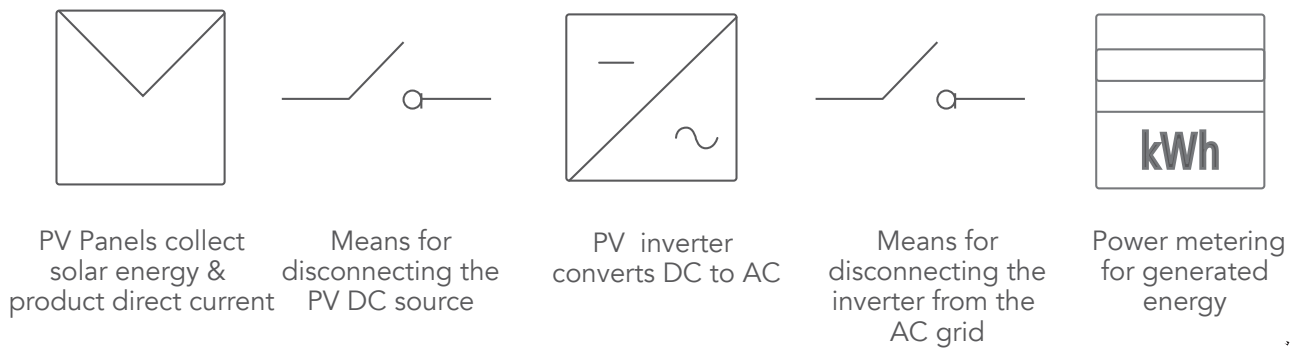

Figure 96: **Block diagram of PV System indicating location of disconnects**



Figure 97: **Fuses**

- One of the most essential aspects of electrical wiring of photovoltaic systems are fuses. Fuse provides integral safeguard against overcurrent that could otherwise damage your valuable PV equipment. It is a type of low resistance resistor that acts as a sacrificial device responsible for protection from over current.

- "Fuse blow for a specific reason", whenever a blown fuse is found, investigate the reason behind it. The essential component that will deteriorate in the fuse is a metal wire that melts when an excessive amount of current flows through it. Some common explanations for current fluctuations that result in blown fuses are:

1. Short circuit
2. System overload
3. Other device failures (modules etc.)
4. Lightning
5. Static electricity

- A typical fuse will blow at an ambient temperature under the following conditions

%of amp	Time to Blow Fuse
110%	4 hours minimum
135%	1 hour maximum
200%	5 minutes maximum

- When replacing fuses, it is essential to source the appropriate size, type, and rating. Do not assume that the fuse being replaced is the correct size, type, and rating, because an incorrect rating or size could be a reason for the fuse to blow.

- It might be necessary to consult the product manual to confirm the correct fuse to be sourced.



The small element cross-section melts quickly under short-circuit conditions. The effective heat transfer allows the fuse to carry harmless overloads.



When a sustained overload occurs, the element will start generating heat at a faster rate, then the heat can be passed to the filler. If the overload persists, the element will start reaching its melting point and would open.

Effect of blown Fuse



Figure 98: **Blown fuse**

Example:

Consider a situation, where a fuse was burnt in the array junction box and the output of that string was zero since many days. The same should have been identified just by looking at the SCADA system. Although SCADA was showing zero output, but due to the small and overlapping values shown in

the graphical user interface on the computer screen, it was nearly impossible for anyone to identify this problem. As a result, the output of the whole array was sacrificed for several days, which could be avoided, just by changing the blown out fuse.

Let us consider an example of the financial effect of a blown fuse on a 5 kW system.

Parameter	Specifications
Plant Capacity	5 kW
Max Power@STC	250 Wp
Total No. of Modules	20 modules
No. of strings	4
No. of modules in each string	5
Performance Ratio (PR)	85%
Sunshine Hrs.	5 Hrs.

Assume fuse is blown in single string

Daily generation	15.9 (Fuse Blown)	21.25 (Fuse not Blown)
Units gained = (21.25 – 15.9)	5.35 Units	
Savings = (5.35 × 5.14**))	Rs. 27 / day	
Monthly Saving = (Rs 27 × 30)	Rs. 810 / month	
Annual Saving = (810 × 12)	~ Rs.9,720 /year	

Daily energy loss = No of modules (single string) × Watt peak rating of modules × PR × Sunshine hours

Daily generation = Total no of modules × Watt peak rating of modules × PR × Sunshine hours

*Assumption: 85% PR. The performance ratio tells us how well a plant is engineered to generate electricity at a given module efficiency and a given irradiation level.

**Assumption: Rs. 5.14/kWh is the power tariff rate of an average residential customer

Table 8: **Financial analysis of blown fuse**

BATTERIES



Figure 99: **Battery sulfation**

The goal of battery care and maintenance is to improve the battery's performance and life. Battery life is a highly variable property that depends on a host of factors such as storage temperature and depth of discharge (DOD).

The following needs to be observed during a battery inspection:

- Terminal rusting generally is the main problem of all batteries. Rusting in terminals reduces the current flow to and from the battery. This considerably affects the life of battery and inverter efficiency. Maintenance free batteries also need care against rusting in terminals. Contacts affected by rust, restrict

the charging current and slow down the rate of charging; this in-turn reduces the life of the battery which is irreversible.

- Clean the battery terminals at least once in a month. About 80% of failures are caused by sulfation (a process where Sulphur crystals form on the battery's lead plates and prevent chemical reactions from happening). When the battery has a low charge or electrolyte level then sulfation occurs. Thus, it is very important to monitor, maintain and control sulfation in flooded batteries. To do this you will need distilled water, digital voltmeter, temperature compensating hydrometer and proper safety gear.

CHAPTER 2

Maintenance & Troubleshooting

BASIC LEVEL

Cables

Many plant outages occur due to cable breakdowns. Problems arise in cables largely due to the following reasons:

- Optimizing sizing
- Cable routing
- Voltage drop

The following checks must be performed during inspection & maintenance



Figure 100: **Incorrect cable routing**

- **Check for cable routing.** The cables shall be routed properly and fastened with clamps to avoid any damage to the cables. If the cables are not properly routed and the wires are left hanging, this may cause damage to cables because of rodents, squirrels and other pests or can cause hazard when people walk around the terrace.



Figure 101: **Proper cable routing**



Figure 102: **Incorrect cables connection looped tightly**



Figure 103: **Incorrect cables connection looped loosely**



Figure 104: **Correct cabling connection**



Figure 105: **Properly insulated**



Figure 106: **Improper insulation**

- **Closed Loops & Open Loops.** Many times we notice that cables are not properly looped. Sometimes the cable loops are very tight or very loose. Loose connection may lead to a fire hazard and tight connections may lead to breakage of the cable. Wiring of the loops should be of proper diameter.

- Check that all cable connections are tightened and securely fastened.
- Check that all cables are properly insulated, without insulation damage. Check for quality of outer sheath and conductor insulation.



Figure 107: **Incorrect – Cable conduit are not closed**

- Check whether separate single core cables have been used for the positive and negative conductors of DC circuits.
- Check whether unused cable entries have been closed. All unused cable and conduit openings shall be plugged with blind plugs or caps to prevent entry of dust, insects, squirrels, rats and other pests.

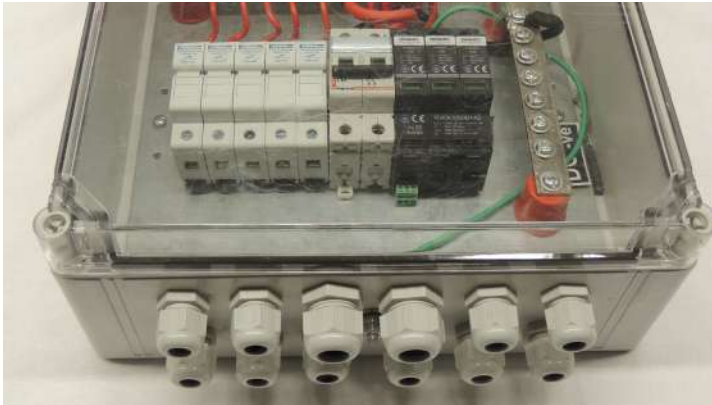

Figure 108: **Correct- Cable conduit are closed**



Figure 109: **Incorrect - Conduits are damaged**

- Check for the quality of conduits (diameter, wall thickness)



Figure 110: **Correct - Conduits are in proper condition**

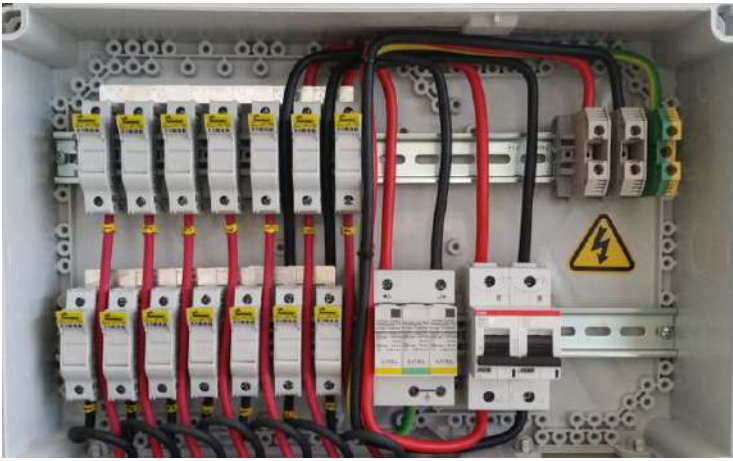

Figure 111: **Cables are labelled properly**

- Electrical rooms, niches, switch boards and distribution boards should be kept clean and neat. The immediate surroundings of all electrical systems should be kept clean and free to allow access at any time.
- Check for proper labeling of cables

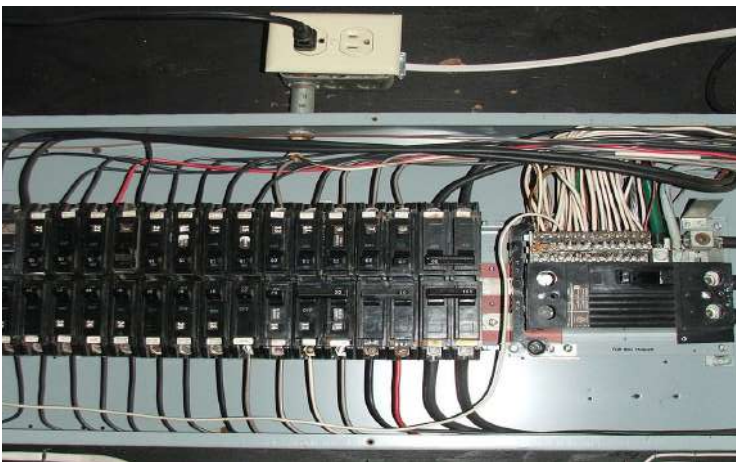

Figure 112: **Cables are not labelled properly**



Figure 113: **Cables are tied using cable tie**

- PV modules cables are generally tied by a 'cable tie'. Check that they are tied properly and not loosely mounted.

- The MCB's, isolators, connectors, switches, fuses and other components should be of ratings that match the cables, wires and equipment to be protected by these components.
- Check for all cables and wires should be of adequate current rating.
- Cables and wires should not bypass fuses and breakers.
- All indoor enclosures should be of IP 54 or better rating.
- All outdoor enclosures should be of IP 65 or better rating.

It is observed that a very common mistake

is to use a fuse that is rated for 1000 VAC on a DC disconnect that is rated for 1000 VDC. At first sight, the cable size and the current rating may seem correct, however, the voltage rating (a small description on the

fuse) is even more important than the current rating in some circumstances. Unless DC application ratings are provided by the fuse manufacturer the AC rated fuses **SHOULD NOT** be used in DC voltage circuits.



Figure 114: **Proper choice of fuses - Note ac and dc rating of fuses**

- Colour coding of wires and cable conductors shall be strictly followed as per article 3.6 of the National Electrical Code.

System	Item	Color
Supply AC system	Phase 1	L1 Red
	Phase 2	L2 Yellow
	Phase 3	L3 Blue
	Neutral	N Black
Apparatus AC system	Phase 1	U Red
	Phase 2	V Yellow
	Phase 3	W Blue
	Neutral	N Black
Supply DC system	Positive	L+ Red
	Negative	L- Blue
	Mid wire	M Black
Supply DC system (single phase)	Phase	L Red
	Neutral	N Black
Protective conductor	PE	Green and Yellow
Earth	E	No color other than the color of the bare conductor. If insulated, the color for insulation should be chosen to avoid those listed above for designation of other conductors

Mounting Structures



Figure 115: **Good Installation**

- Visual inspection of each component as per plans - the model number, Standards etc.
- For the Rooftop systems the mounting must be secure and weather tight
- If it is a roof mounted system, ensure that the roofs are capable of handling additional weight of PV system
- Proper ventilation, must be provided behind array to prevent overheating



Figure 116: **Bad Installation**

- Cable entry must be weather proof
- Ground the system parts correctly in order to reduce the threat of shock, hazard and induced surges
- Aluminum should not be placed in direct contact with concrete
- Ensure the design meets the local utility interconnection requirements
- Check mounting structures for rusting



Figure 117: **Rusting of Mounting structure**

- and corrosion.
- Array frame must be correctly fixed and the material used should be corrosion free
- Check if all the clamps are properly



Figure 118: **Loosed clamps**

- tightened.
- Check the distance between rows of Solar PV modules (passage for cleaning and maintenance).

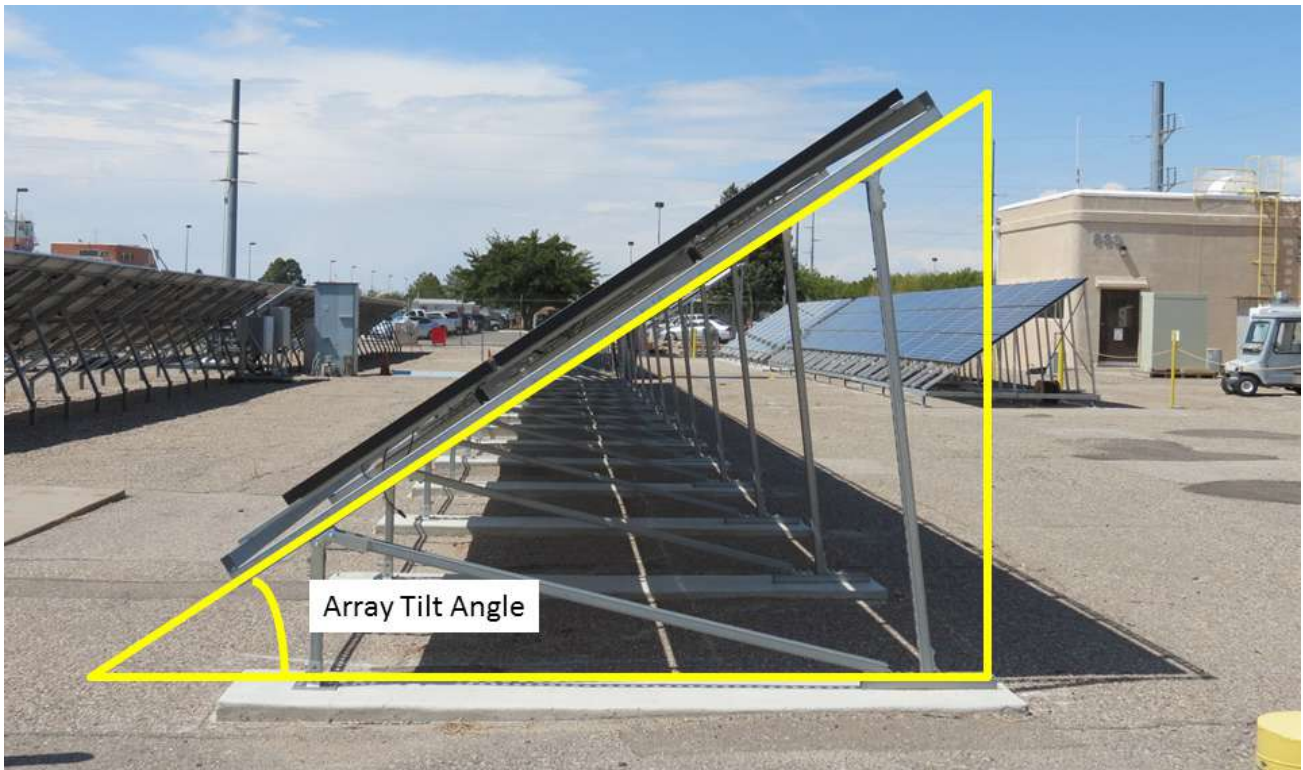

Figure 119: **Tilt angle of PV Modules**

- Check the tilting angle. The optimal tilt of the fixed PV module is approximately the degree of latitude of that location (facing South in India). However, it is an acceptable practice to install the PV modules at lower tilt angles (in the range of 10° to 15°) on flat roofs/ terraces for the following reasons:

1. PV modules installed at lower tilt angles encounter lesser wind (and hence, uplift) forces. Hence, the PV modules and their mounting structures can often be installed safely on the flat roof/ terrace by simply adding more weight (like bricks) and using wind blockers rather than using
2. PV modules installed at lower tilt angles cast shorter shadows, thus allowing lower inter-row spacing between the PV modules. Hence, a higher capacity (in kW) can be installed in a given roof/ terrace area.
3. Mounting structures for PV modules at lower tilt angles are lighter, and thus, reduce the cost of the overall PV system.
4. Mounting structures for PV modules at lower tilt angles are simpler, thus they reduce the time for installation (and hence, also reduce the cost).

NOTE:

If a customer notices that a nearby building which has the same plant capacity but different tilt angle, it should be noted that with the difference in tilt angle, output varies.

Protection Devices



Figure 120: **Fuses - Burnt out**

- Visually inspect the fuses
- Large surges can immediately destroy equipments and can also melt conductors. Typical location for surge protection are at the ac output and dc input of inverter, and dc combiner boxes. The best surge protection is a well grounded system. SPD's are connected in parallel with the

circuit that is being protected so when the device fails, the circuit will be energized but will no longer be protected from surges.



Scan for video meant for demonstration of working of SPD's



Figure 121: **Grounding**

- The reasons for grounding include the following:
 - To prevent voltage potentials and current on conductive surfaces where it could cause an electric shock, start fire or cause death.
 - It provides a path for fault-current flow, helping to ensure the proper operation of overcurrent devices such as circuit breakers and fuses.
 - To limit spikes and surges from lightning or other high-voltage conditions.
 - To stabilize voltage and provide a common reference point (the earth).



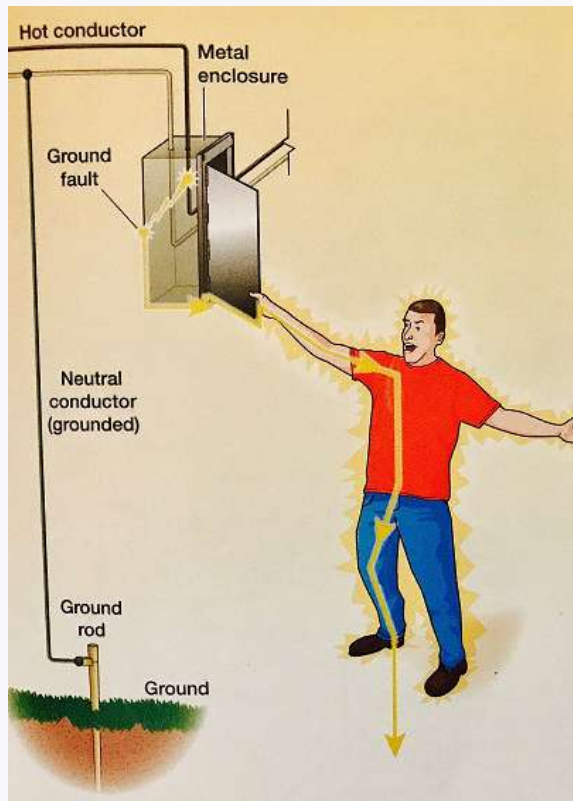

Figure 122: **No Equipment Grounding**

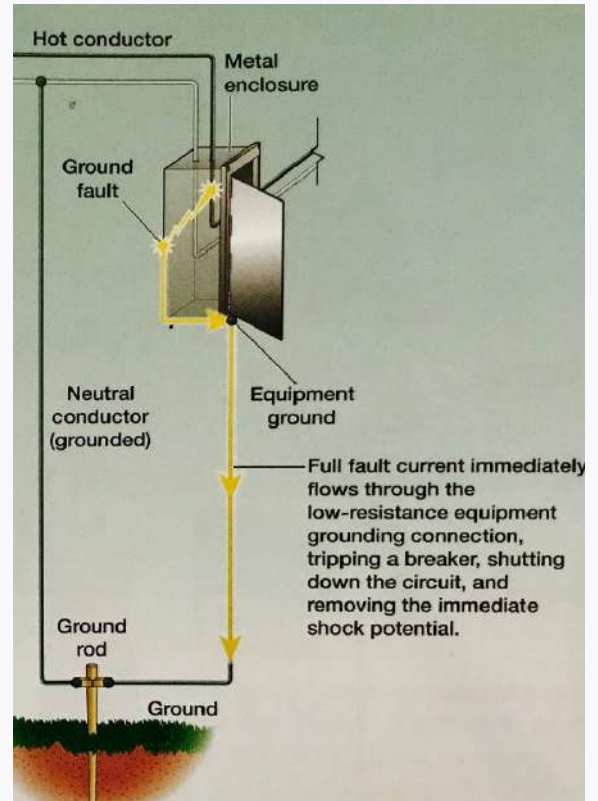

Figure 123: **Proper Equipment Grounding**

- The above figure on the left shows a person getting an electric shock due to improperly grounded metal enclosure. In this illustration the ground fault has occurred. So when the person unwittingly touches it, current flows through their entire body to ground causing shock or death. The figure on the right shows a properly grounded system, with the metal enclosure connected to the ground rod by the equipment grounding conductor.

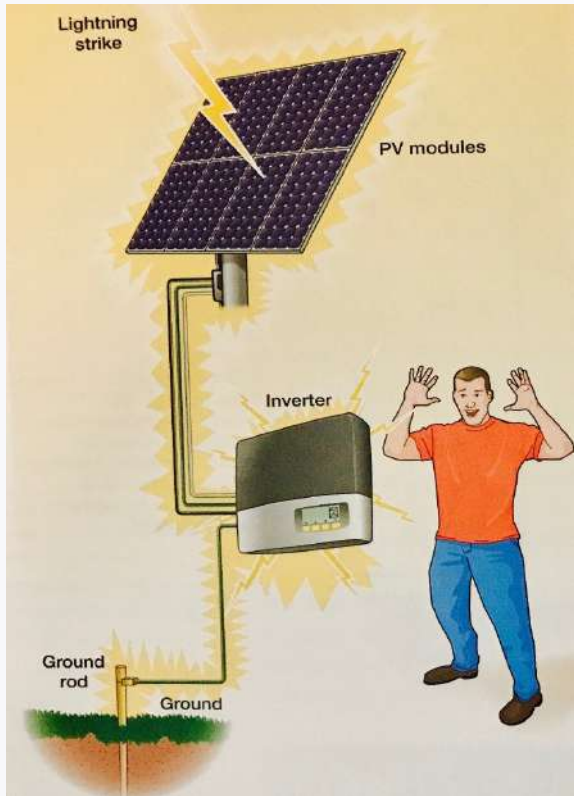

Figure 124: **Poor Lightning Protection**

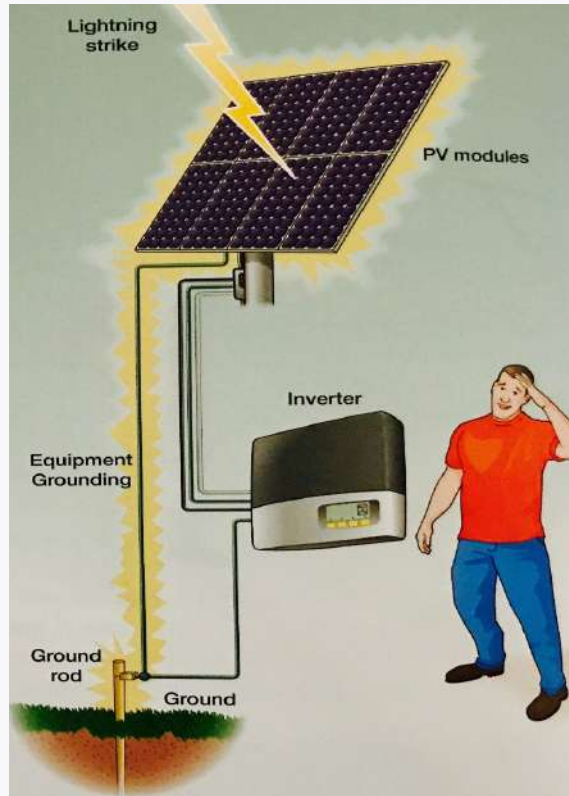

Figure 125: **Good Lightning Protection**

- The above figure on the left shows the poor grounding that increases the risk of damage from lightning strikes. In this scenario, the only path for lightning is through the wiring from the array to the inverter and then on to ground. This can likely damage the inverter. The figure on the right shows better lightning protection with an additional array grounding electrode conductor connected directly from the PV modules to a ground rod. With this lightning arrangement, the risk of lightning damage is greatly reduced.

Batteries

- Visual Inspection of battery



Figure 126: **Proper condition of battery**



Figure 127: **Improper condition of battery**

- Topping up of water inside the battery. Nowadays most of the inverter batteries are equipped with an inbuilt electrolyte level indicator. Mainly people use tap water for topping up. Some local technicians suggest filling of boiled and cooled tap water. Remember these things will not substitute distilled water. Tap water generally contains

some impurities, minerals and other chemicals which reacts with the battery electrodes and causes life reduction. Some people use the water drained from air conditioners, which is comparatively a better alternative but not the best. During maintenance one must check the electrolyte level regularly.

How to check the fluid level?

Do this for only unsealed batteries (FLA) - these are the flooded lead acid batteries. Open your battery cap and look inside. Make use of distilled water. Most batteries will have a "fill line" indicator, indicating the electrolyte level.



Figure 128: **Refilling battery**

How to clean the battery terminals?

Monthly clean the battery terminals and surface. Switch OFF the inverter and its power supply. Remove the battery cables from terminals. While removing the terminal

connections, remember, you must take necessary safety measure against possible shorting and sparks.



Figure 129: **Improper and proper battery terminals**

How to Read a Hydrometer?

A hydrometer will help you to determine if the battery bank is getting fully charged, and whether any individual cells are falling behind. You should be aware that a hydrometer will give you false readings under the following conditions.

1. After adding water: For pure water to mix throughout the cell, it takes time and some bubbling during finish charge. A hydrometer will show a greatly reduced reading until the fluid mixes.
 2. Low temperature: As battery temperature drops, the fluid becomes denser. A temperature compensating hydrometer is best. Otherwise, for every 10°F below 70°F, subtract 3.5 points from the reading.
 3. Time lag during recharge: As the battery recharges, the fluid becomes denser between the plates. The hydrometer reads the fluid above the plates. You will get a delayed reading until the fluid is mixed by the movement of bubbles during finish charge. The voltage will rise steadily, providing an indication that something is happening.
 4. During discharge, you will get a true hydrometer reading because the fluid becomes less dense and will circulate to the top. Any time a hydrometer indicates a fully charged cell, you KNOW it is fully charged.
- If flooded lead acid batteries are used check electrolyte level and top up if required. Wipe electrolyte residue from the top of the battery. In case of excessive corrosion, the terminals be able to removed very easily. In that case don't use excessive pressure by tapping, which can break the terminal internally. Take a cup of boiling water and add two to three spoons of baking soda in it. Pour the same into the battery terminals. Wait for a minute and remove the terminal connections.

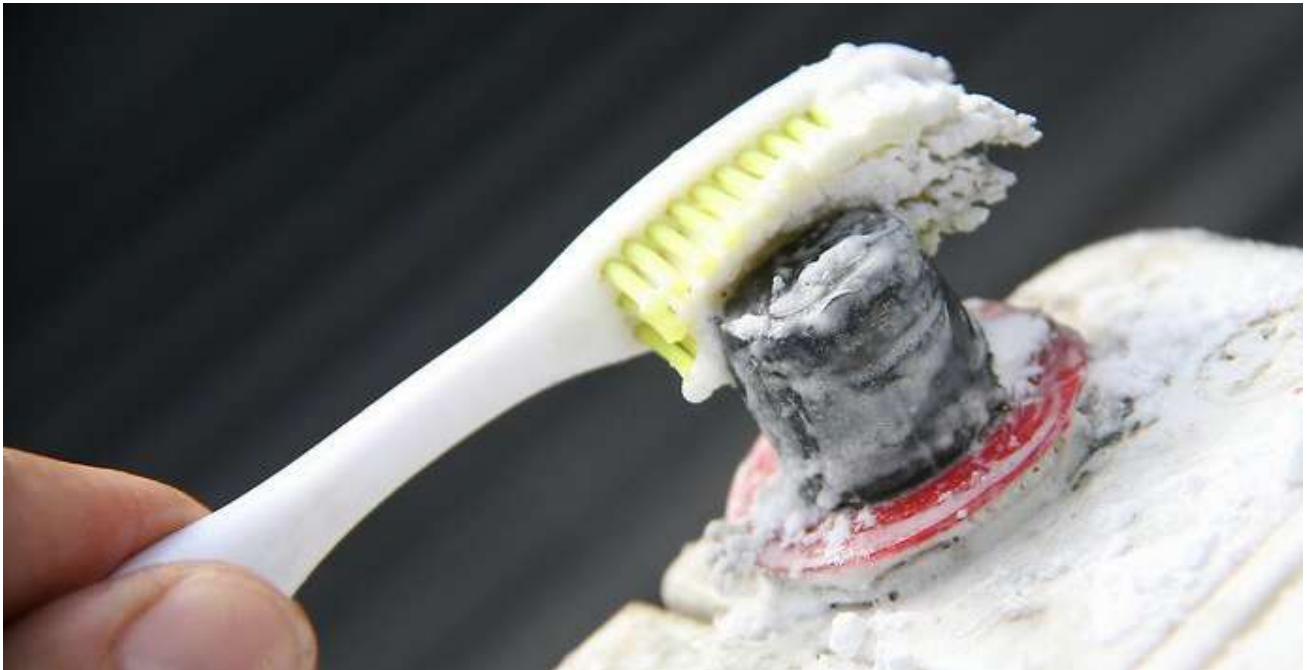

Figure 130: **Battery cleaning using baking soda**



Figure 131: **Tightened battery terminals**

- Inspect all corrosion and loose connections. Clean and tighten as necessary. If you find that the nuts and bolts are rusted, replace it or clean it by using kerosene or petrol. Put some dry baking soda into the battery

terminals and rub it with a wet tooth brush. After that clean it with a soft dry cloth. Replace the connectors back, tighten them well. After cleaning add anti-oxidant to the exposed wire and terminals.

- Observer Battery State of Charge (SOC) using hydrometer. In case of VRLA battery use voltmeter to measure voltage and SOC.

Parameter	Possible Cause	Preventive Measures
Low electrolyte level Electrolyte Leakage	Check if battery is overcharged Check if battery container is broken leaking Check if load is too large	Add distilled water Report dealer or manufacturer Replace battery
Battery voltage remains low	Check if load is too long Check if there is shadow Check if weather is cloudy for several days Check if load is defective Check if charge controller is too small for array	Repair or replace load Reduce operating time Remove shadow Wait till weather is sunny and restrict use of load Repair or replace load
Battery voltage remains constantly high	Check if charge controller is faulty Check if battery capacity is too small for array Check if charge controller is mis-adjusted	Increase battery capacity Replace the charge controller Increase battery capacity Adjust charge controller
Battery do not accept charge	Check if load is too large Check if load is too long Check if there is shadow Check if weather is cloudy for several days	Repair or replace load Reduce operating time Remove shadow Wait till weather is sunny and restrict use of load
High water loss due to overcharging	Check if batteries are overcharged	Repair or replace charge controller
Voltage loss overnight even when no loads are on	Check if blocking diode is faulty	Replace diode

Charge Controllers



Figure 132: Charge controller

1. Refer to the manufacturer's instructions, if available, for the specific charge controller in the system.
2. Check all terminals and wires for loose, broken, corroded, or burnt connections or components.
3. Check if all the displays, LED indicators and status monitoring systems are in operation.
4. Check for overcharge and undercharge protection of charge controller is functioning correctly.

Monitoring of Rooftop PV System

It is useful to install a monitoring and data logging device for a solar PV system. Many solar grid inverters have a built-in monitoring system that can be connected to internet for the purpose of remote monitoring. There are also third party system monitoring and data logging devices available. A PV system can be monitored at various levels based on the capacity of the PV system and type of involvement of the stakeholder generally as follows:

At PV module-level

This is done using either micro-inverters or DC-DC converters/ optimizers at each module, where monitoring is provided as an added functionality.

However, such micro-inverters/ converters/ optimizers increase the capital cost of the PV system, and hence, are not popularly used.

At string-level

This is done mainly using current sensors to each string in the string junction boxes which are connected to a supervisory control and data acquisition (SCADA) system. In string monitoring systems, the electrical output of each PV string is compared with each other and also as a function of the ambient weather parameters.

Hence, any under-performing string can easily be identified and the under performance can be detected only to a few PV modules. However, the cost of such systems are justified in bigger PV plants. Typical parameters that are monitored and logged are:

- Day solar energy produced (kWh)
- Cumulative solar energy produced(kWh)
- Maximum DC voltage (V)
- Maximum DC current (A)
- Cumulative hours of operation (h)
- Maximum AC voltage (V)
- Maximum AC current (A)
- Maximum AC frequency (Hz)
- Minimum AC frequency (Hz)
- Errors

Figure below shows the SCADA image showing the energy generation of 5 kW installed capacity of the Rooftop PV System located at Ahmedabad, Gujarat.

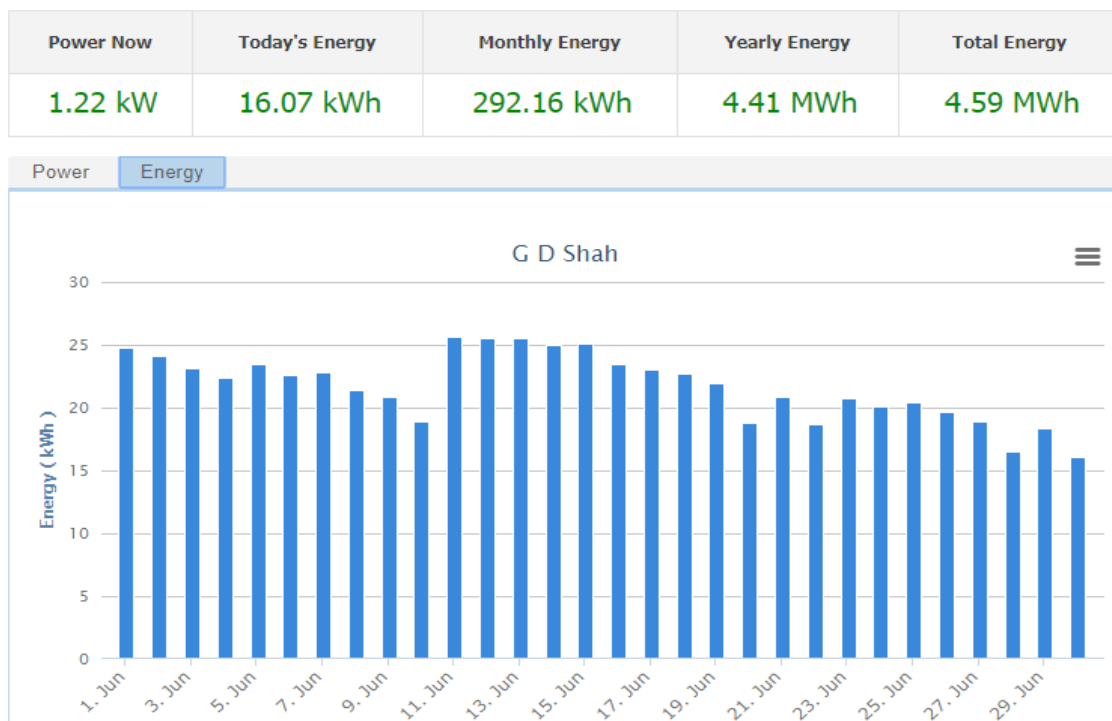

Figure 133 SCADA: **Displaying the daily energy generation of PV System**

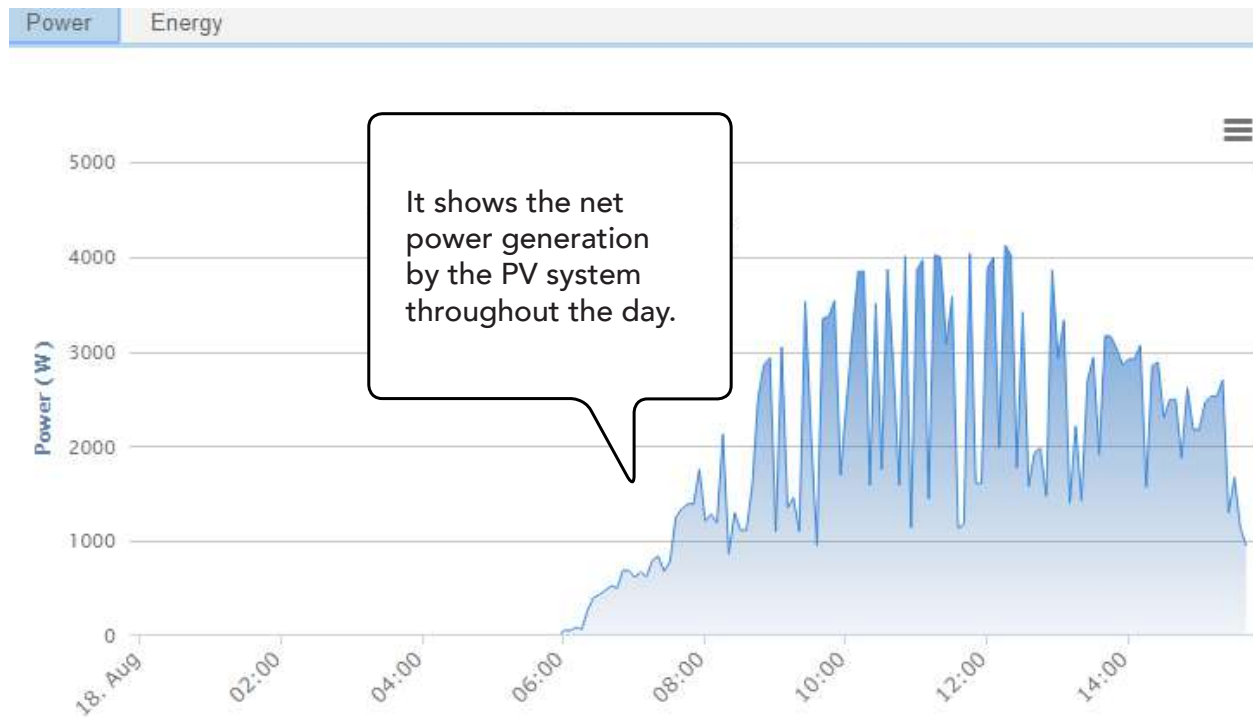

Figure 134 SCADA: **Displaying the daily power generation of PV System**

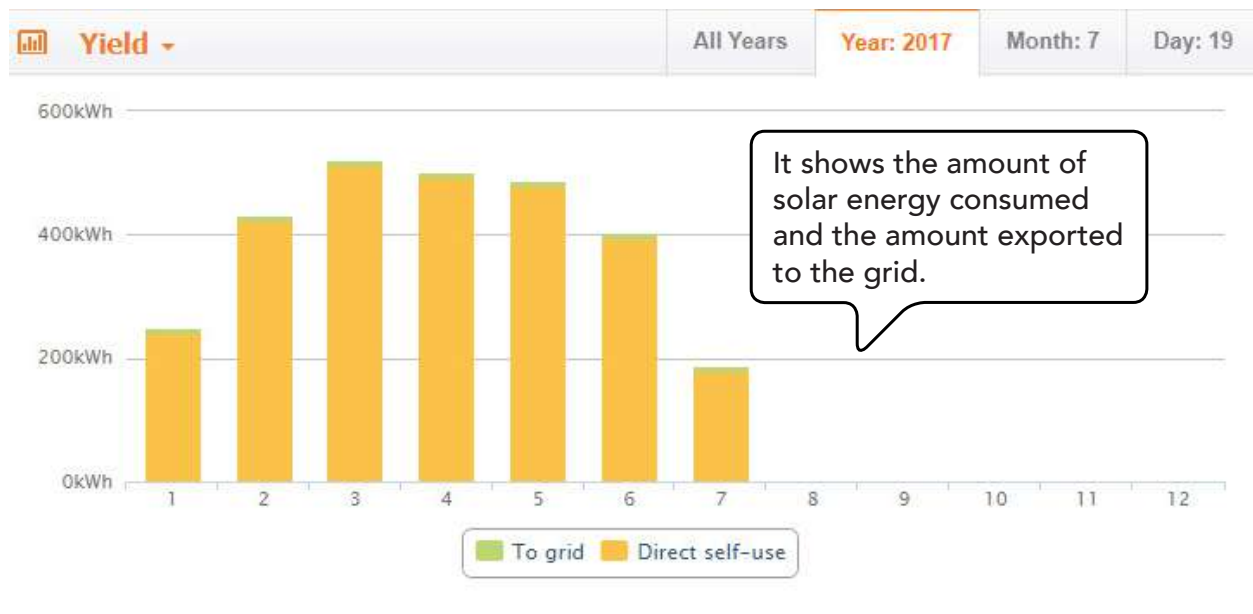

Figure 135 SCADA: **Displaying units consumed for self-use and exported to grid**

At inverter-level

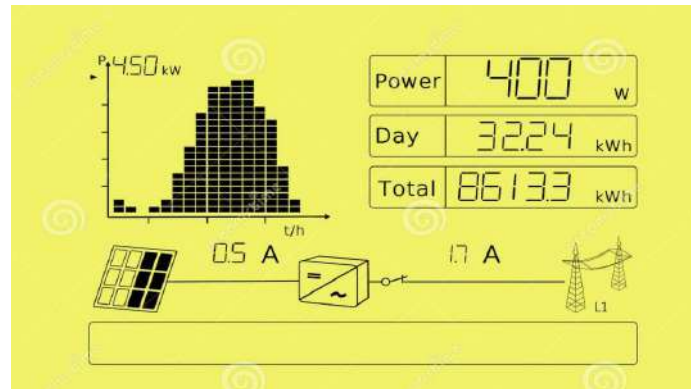

Figure 136: **Inverter display screen showing units generated by PV system**

Most PV inverters come with a monitoring functionality indicating critical parameters such as instantaneous currents and voltages, input DC and output AC power, energy generated during the day or during a given timeframe, etc. In addition, most inverters also allow connectivity to their proprietary or third-party weather monitoring equipment. The display panel of the solar grid inverter may also show the cumulative energy production. But if the inverter becomes

defective or is replaced by the manufacturer with a new inverter, the energy generation data is lost. Hence it is recommended to install a solar energy generation meter.

The data of the inverter can be either read from their display or can be extracted by connecting USB or RJ45 cables, or wirelessly using Wi-Fi, radio frequency (RF) or Bluetooth. Inverters may also be monitored remotely using proprietary or third-party equipment using GSM/ GPRS or even locally available Wi-Fi.

At Meter-level



Figure 137: **Net metering display screen showing units consumed by consumer**

Meter-level monitoring of a rooftop or any other PV is the most critical for Utilities as well as Investors, as the energy meter is directly linked to each Stakeholder's revenue.

Meter-level monitoring can be done either

entirely manually by the meter reader once during a billing cycle; or at another extreme, on a real-time-basis using remote wired or wireless communication.

conductor 2, connect the one probe of the Multimeter to conductor 2 and other probe to the tested conductor (at Location A). Instruct the staff at other end (at Location B) to short conductor 2 with the tested conductor.

- Test continuity of all other conductors as above.

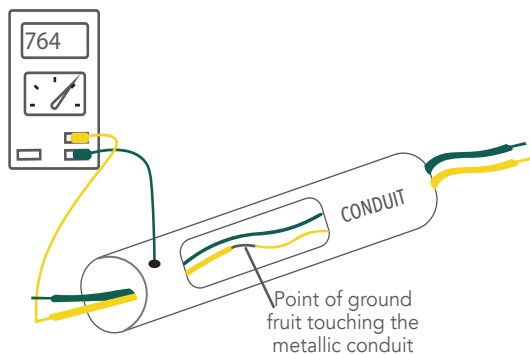
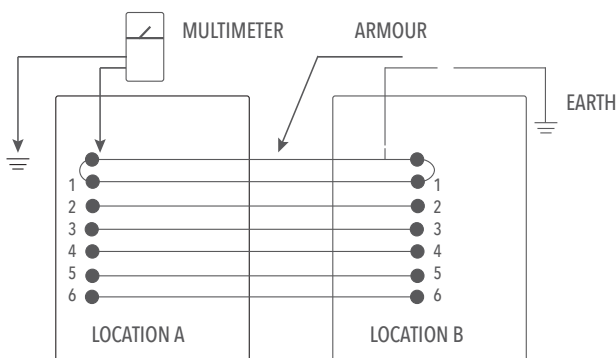

Figure 138: **Continuity test**

In order to ensure integrity of circuits, check for insulation values periodically. If a sudden fall in the value of insulation is observed during the test, the cause should be investigated and immediate action should be taken to repair or replace the defective cable.

Insulation Test

Tools and Instruments required:

- Insulation Tester (Megger) 500V DC2
- Wire nipper
- Screw Driver set
- Box spanner
- Crocodile clips, must be equal to the maximum no. of cores of cable to be tested.

This test is carried out to measure the insulation resistance of the cable under test. Procedure is as follows:

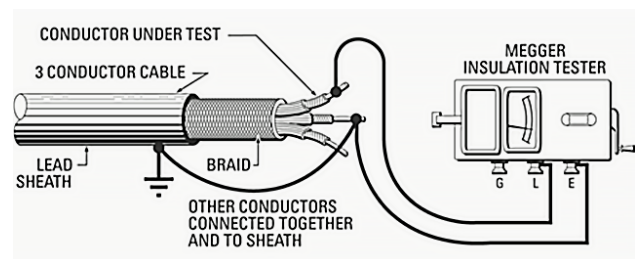

Figure 139: **Insulation test**

- By this we can measure individual insulation of conductor's w.r.t. earth.
- Connect conductor under test to the Line terminal of the megger.
- Connect earth terminal of the megger to the earth. Rotate the handle of megger or press push button of megger. The reading of meter indicates the insulation resistance of the conductors. Insulation reading should be recorded after applying the test voltage for about a minute till a steady reading is obtained.
- Replace the conductor at line terminal of the megger by another conductor under test and repeat the same process.

Protection Devices testing methods & techniques

Fuses can be checked under any test conditions. It is easy to visually inspect the fuse to see if it has blown, majority of fuses have solid, non-transparent bodies that hide the element from view.



Figure140: **Testing using clamp meter**



Figure 141: **Connect test cables**

To test if the fuse is blown, we require a Multimeter. Once configured, a Multimeter can measure the resistance of the fuse element. Resistance is measured in Ohms 'Ω'. Procedure for testing a fuse is described further:

1. Confirm system is de-energized with a voltmeter.

2. Connecting the Test Leads

The red lead should be connected to the Ω or Ohms socket. The black lead should be connected to the Common socket.

3. Opt for the Correct Setting

If there is a separate ON switch, please turn the meter ON. You can see in the picture that the Ohms range is illustrated by a light green band in the lower left area.

The 5 different Ohms range settings on this Multimeter are:

2000k = 2,000,000 ohms or 2 Mega ohms (highest resistance setting)

200k = 200,000 ohms

20k = 20,000 ohms

2k = 2,000 ohms

200 = 200 ohms (lowest resistance setting)



Figure 142: **Select the appropriate ohm's rating**

4. Measure the Fuse

- Remove the fuse to be tested from the fuse holder unless it is clear that no alternative paths exist that would provide a false reading

NOTE:

Make sure that you have turned off power and disconnected the power source, if you wish to test a fuse still located in the circuit in order to avoid a possibility of electric shock.



Figure 143: **Fuse testing using Multimeter**

- Place the fuse on a non-conducting surface such as plastic, laminate or wood.
- By using metal tips of the testing leads touch the metal caps at each end of the fuse.
- There is no polarity in fuse, so you can use any lead for either fuse cap. Ensure to make good contact by touching a clean metal surface on each cap. Note the reading displayed on the Multimeter.

5. Understanding the Reading



Figure 144: **Display indicating Good and Blown fuse**

Good Fuse: If the meter reading changes to a low resistance value (similar to the result of touching the 2 leads together).

Blown Fuse: If the meter reading does not change and the display still shows the original 100% resistance state.

6. Look at the fuse and confirm the size, type, and rating of the fuse

7. If the fuse fails the test or is not properly rated in size or type, replace the fuse with the correct fuse

NOTE:

Always test replacement fuses before installing to confirm the fuse was good when it was placed.

- Fuse are sold in standard size (6, 8, 10, 15, 20, 25, 30 amps etc.). The NEC states that you must select the closest size at or just above.
- If the ampacity value is 13.42 amp thne a 15-amp Fuse must be used.

Five Steps to Sizing Fuses for Photovoltaic Systems

For sizing string and array type fuses for photovoltaic source circuits and photovoltaic output circuits as per the 2011 National Electrical Code the following steps should be used:

Step 1: Calculate the maximum circuit current

Step 2: Calculate the nominal fuse ampere rating

Step 3: De-rate fuse due to abnormal ambient temperature (if required)

Step 4: Calculate the fuse amps rating

Step 5: Confirm if fuse will protect conductors

Earthing & Lightning Protection testing methods & techniques

At this time, turn off all disconnect switches. Use an ohmmeter to check the continuity of entire grounding system.

- Make sure that all module frames, metal conduit, connectors, junction boxes and electrical components are grounded.
- By making use of a DC voltmeter, check the polarity of all system components and wiring
- If plastic conduit is used, make sure a grounding wire has been run through it to provide continuous grounding or if metal conduit is used, the conduit itself functions as the ground conductor, if allowed by code. If not allowed by code, a grounding wire must be used.

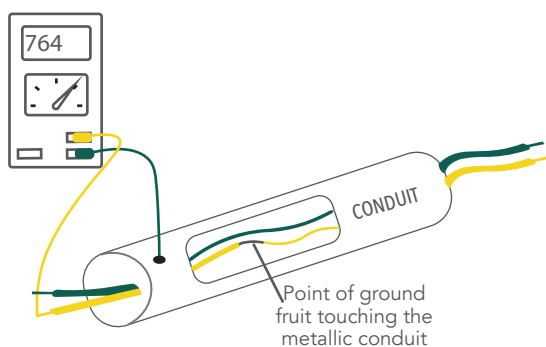

Figure 145: **Cable continuity test**

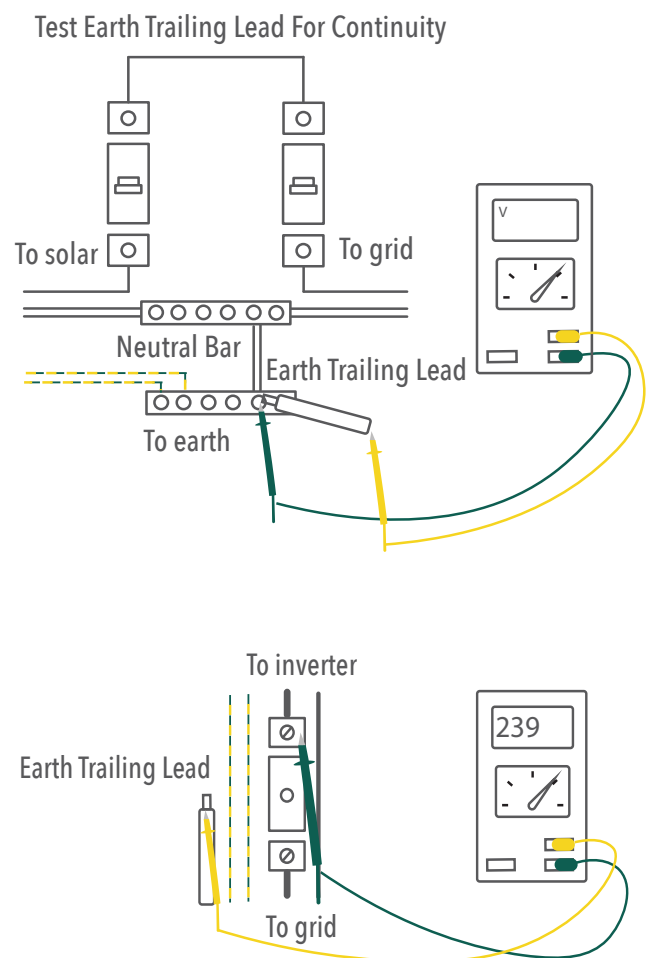

Figure 146: **Earthing & Lightning Protection testing methods & techniques**

Batteries

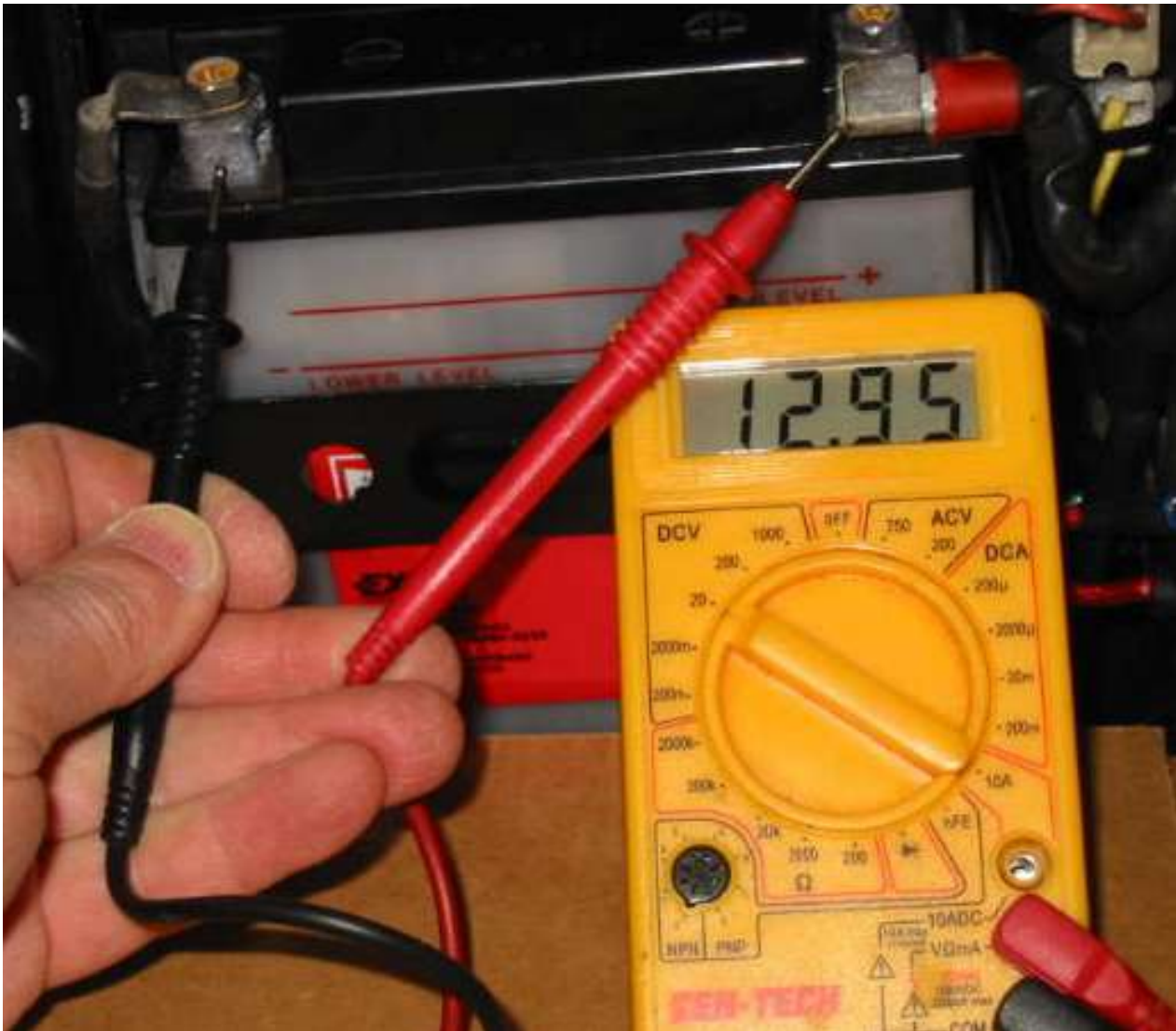

Figure 147: **Battery Load test using Multimeter**

Checking State of Charge (SOC)

A hydrometer describes the state of charge by determining the specific gravity of the electrolyte. Usually the specific gravity of electrolyte is between 1.120 and 1.265. At 1.120, the battery is fully discharged. At 1.265, it is fully charged. Determine SOC through actual load test:

1. Use a Multimeter
2. Operate the system load from the batteries for five minutes. Turn off the loads and disconnect the batteries from the rest of the system.
3. Measure the voltage across the terminals of each battery.

SOC	Specific Gravity	Battery Voltage	
		12 V	24 V
100%	1.265	12.68	25.35
90%	1.250	12.60	25.20
80%	1.235	12.52	25.05
70%	1.225	12.44	24.88
60%	1.210	12.36	24.72
50%	1.190	12.28	24.56
40%	1.175	12.20	24.40
30%	1.160	12.10	24.20
20%	1.145	12.00	24.00
10%	1.130	1.85	23.70
0%	1.120	11.70	23.40

Table 9: **Typical Battery voltages as function of state of charge**

Open circuit Voltage (Voc)		State of Charge (SOC)	
2 V Battery	6 V Battery		
2.12 or more	6.36 or more	12.72 or more	100 %
2.10 to 2.12	6.30 to 6.36	12.60 to 12.72	75-100 %
2.08 to 2.10	6.24 to 6.30	12.48 to 12.60	50-75 %
2.03 to 2.08	6.90 to 6.24	12.12 to 12.48	25-50 %
1.95 to 2.03	5.85 to 6.90	11.70 to 12.12	0-25 %
1.95 or less	5.85 or less	11.70 or less	0 %

Table 10: **Voc and corresponding SOC for deep cycle lead acid batteries during a load test**

Charge Controllers

- Testing procedure for shunt charge controllers (12 V System)

1. Set Multimeter to appropriate DC voltage range to measure voltage between array positive and negative terminals.
2. Measure the DC voltage between the battery positive and negative terminals on the controller.
3. If the controller is operating properly, it should lie between 13.5 - 14.5 volts per module in series.

- Testing procedure for series charge controllers

1. Disconnect all wiring from the controller, expect the temperature compensation probe. Set the power supply to zero volts.
2. Set Multimeter to the appropriate DC voltage range to measure the voltage between array positive and negative terminals.
3. Watching the meter slowly increase the power supply voltage until it is equal to the nominal rating of charge controller
4. Continue to increase the voltage until the meter reads 'one-half' above the charge termination setting of the controller. At this point, the "charging" LED should go

off.

5. Record the charge termination voltage and compare it with manufacturer's datasheet.
6. Turn the power supply voltage back to zero, then move the meter and power supply to the positive and negative battery terminals on the charge controller.
7. At first, the low voltage disconnect LED may be OFF. Slowly, increase the voltage. Once you supply enough voltage to operate the controller, still below the low voltage disconnect setting, the LED should be ON. When the voltage is higher than disconnect setting, the LED should go OFF.
8. The voltage at which the LED comes ON is the low battery reconnect voltage and should be recorded and compared with the manufacturer's datasheet.

NOTE:

Since many charge controllers have time delay on the load reconnection, it may be necessary to leave the power supply connected for a few minutes. The time required varies with the model of charge controller.

Parameter	Possible Cause	Preventive Measures
Irregular controller operation or loads being disconnected improperly	Timer not synchronized with actual time of day	Wait for automatic reset. If not then Disconnect array and wait 10 seconds and reconnect array
Fuse to array blows	Low battery voltage High surge from load	Repair or replace battery Use large wire or add batteries in parallel
	Load switch is in wrong position on the controller	Reset switch to correct position
	Array short circuited with batteries still connected	Disconnect batteries when testing array's short circuit current.
Fuse to load blows	Current output of array too high for charge controller Current draw of load too high for charge controller Surge current draw of load is too high for charge controller	Replace charge controller with a high rating Reduce load size or increase charge controller size Reduce load size or increase charge controller size

KEY POINTS TO REMEMBER

1. PV module cables are generally tied with 'Cable tie'
2. The cable tie life span is very short and it may get damaged shortly. Check and replace all damage cable ties so that cable may not be in hanging condition
3. Do not open or work in electrical boxes, particularly in wet conditions.
4. It is recommended to have a periodic maintenance schedule (Refer Annexure) for visual inspection of the status and condition of all the array connections and fuses inside the array junction boxes, along with monitoring the output of each string by SCADA. This periodic maintenance schedule will double check for any abnormalities in the system and will prevent loss of energy generation from any of the strings. Also if possible, the facility of an alarm or visual fault indication should be incorporated in the SCADA system to easily identify the problem.
5. Shut the system down prior to servicing fuses. Make sure that the fuses should never be replaced or tested while the circuit is energized.
6. Do not open or work in electrical boxes, particularly when in wet condition.
7. It is recommended to have a periodic maintenance schedule for visual inspection of the status and condition of all the array connections and fuses inside all the array junction boxes, along with monitoring the output of each string by SCADA. This periodic maintenance schedule will double check for any abnormalities in the system and will prevent loss of energy generation from any of the strings. Also if possible, the facility of an alarm or visual fault indication should be incorporated in the SCADA system to easily identify the problem in the system.
8. Unless DC application ratings are provided by the fuse manufacturer, AC rated fuses should not be used in DC voltage circuits
9. Fuses should never be replaced or tested while the circuit is energized. Shut the system down prior to servicing fuses.
10. Do not work on the equipment until it is isolated from both ac and dc sites generation supplies.

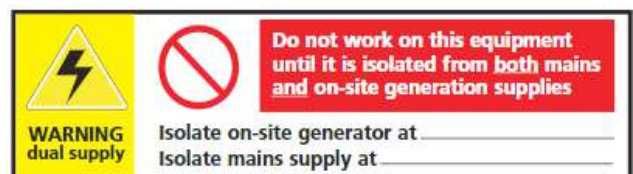

HOMEOWNER



Jagdishchandra Savalia

Q. What role did you play in the project?

A. I am the proud owner of the system.

Q. Location of installation and brief description of site?

A. The system is a 2 kW high efficiency solar rooftop PV plant at my home in Mota Chiloda, Gandhinagar in Gujarat.

Q. Have you noticed any appreciable savings after the installation of the rooftop solar PV system? Has your electricity consumption changed?

A. Our contract load is 5 kW. I have installed a 2 kW solar rooftop PV system. In the month of May 2017, my electricity bill was reduced by nearly 90%. Our electricity consumption is less in winters owing to the fact that the air conditioners are switched off. We have noticed that the rooftop

system performed best from the month of November to March. Therefore, we get quite a good net metering rebate during winter. I am proud to say that my house is a solar powered house! So, I get good net metering rebate during winter. I can say "I have my own power house."

Q. How easy was it to get subsidy and register the project?

A. I decided to opt out of the subsidy scheme although it is quite lucrative. This is because we have used PV Modules made by LG electronics, which is unfortunately not made in India. Only Indian made modules are qualified for the subsidy process.

Q. How was your interaction with the EPC Company? Did they explain the system to you?

A. Yes, they explained the system very



well. They are also monitoring my solar PV system continuously. If the solar PV system has not performed well on some day, they always ask me to check the grid for outages, weather parameters, shading issues and cleanliness of PV modules.

Q. Did you face any problems after system installation? If yes, than how did you manage to deal with it?

A. A major concern is the fact that the utility grid voltage often falls outside the permitted range as per Indian grid standards. This causes the inverter to trip quite often leading to a loss in generation. We have been forced to change the inverter's nominal operational voltage range, which is not really recommended.

Another common problem is that the utility meter readers are quite new to solar systems and therefore often face trouble in reading the net meter. However, these were teething problems which are now sorted out thanks to the proactive engineers at the utility.

Q. What regular maintenance do you practice, for better performance of your system?

A. I ensure that my modules are kept dust free, for which, I clean the modules once in 10 days. One major problem is that of pigeon droppings which are a menace in an urban environment. Sometimes, I even clean the modules on a weekly basis to ensure the system works optimally.



UNIT 5

JOBSITE SAFETY

WHAT WILL WE LEARN?

- General Safety Procedures
- Personal Safety Procedures
- Major safety hazards

CHAPTER 1

General Safety Procedures

Safety must come first. As the solar industry has grown, unfortunately the number of injuries and fatalities has also grown. Every site is unique and requires a detailed analysis of the hazards and plans to mitigate any potential harm. General requirements of a safe work area include:

GENERAL SAFETY

- The access and exit arrangements should be safe and clear of obstacles.
- Communication arrangements should be safe and clear of obstacles.
- Maintain a first aid kit to mitigate accidents involving personnel or any other person who may be in the vicinity.
- Keep tools sharp and clean.
- Don't hold the switch button while carrying a plugged-in tool.
- Consider what you wear - loose clothing and jewelry can get caught in moving parts.
- Disconnect tools when not in use, before servicing and cleaning, and when changing accessories.
- Keep away people who are not involved with the work.



Figure 148: **Insulated tool kit**

- Make use of an insulated tools kit.
- Since the rooftop is located outdoors, adequate precaution should be taken to avoid sunburns, exhaustion, and de-hydration. Use sunscreen, use a hat if necessary, wear light colored clothes and keep drinking a lot of water.
- Always read the site safety notice and act accordingly.

SITE SAFETY NOTICE



Figure149: **Site safety**

SPECIFIC SAFETY



PV Array Junction Box

DANGER
Contains live parts
during daylight.

- Grid connected PV systems are expected to have a lifetime of decades with maintenance/ modifications likely at some point over the period. It makes it essential for the PV system to be protected.
- Switch enclosures must also be labeled with "Danger - contains live parts during daylight".
- Ensure that the solar isolation switch is off and the mains has been isolated. This may be located either on the main fuse board or near the inverter. The solar panels and the wiring to the inverter/fuse board will still remain live.
- If the control equipment or cabling becomes complicated, or closer to the fire. Monitor fire spread, and contact branch operators.
- As with any electricity generating equipment, do not approach or make contact with any parts that are not considered 'dead & earthed', and arrange for the attendance of the electricity authority for advice and guidance.
- Before operating the Inverter, ensure that the power cable and wall outlet have been grounded properly.
- Repairs or testing under power must only be performed by qualified technicians who are familiar with and qualified to work with the Inverter.

CHAPTER 2

Personal Safety Procedure

IMPORTANCE OF PERSONAL PROTECTIVE EQUIPMENT (PPE)

PPE is the last line of defense in protecting workers from hazards in the workplace. The employer must try to eliminate workplace hazards or reduce them as much as possible, before requiring workers to wear PPE, to protect them from a specific hazard

Major Safety Hazards

Types of Hazards

Physical Hazards

Electrical Hazards

Chemical Hazards

Physical Hazard - Personal Protection

Body Part	Protection Equipment
Head	Safety helmet
Eye	Safety Glasses, Goggles
Face	Face Shields
Hands and arms	Gloves
Bodies	Vests
Feet	Safety Shoes

NOTE:

If the right PPE is not worn properly or when needed is not available, or the PPE fails (for example, gloves leak), the hazard still exists; so the worker is not protected. PPE is not the most effective safety measure because it places only a barrier between the employee and the hazard. Workplace hazards that could cause injury include the following:

- Intense heat
- Impacts from tools, machinery and materials
- Hazardous chemicals
- Electric shock
- Fire hazards

Safety Helmet



Protection of the head is very important because injuries to the head are very serious. A hard hat is a type of helmet predominantly used in workplace environments such as industrial or construction sites to protect the head from injury due to falling objects, debris, rain, and electric shock.

Suspension bands inside the helmet divide the helmet's weight and the force of any impact over the top of the head. It provides space of approximately 30 mm (1.2 inch) between the helmet's shell and the wearer's head, so that if an object strikes the shell, the impact is sensed less directly on the skull.

Types of Helmets



Class A Hard Hats

- Protect you from falling objects
- Protect you from electrical shocks up to 2,200 volts



Class B Hard Hats

- Protect you from falling objects
- Protect you from electrical shocks up to 20,000 volts



Class C Hard Hats

- Protect you from falling objects



Class D Bump Caps

- Bump caps are designed to protect you from bumping your head on protruding objects. They are especially made from lightweight plastic



Figure 150: **Incorrect practice - Without safety helmet**



Figure 151: **Correct practice - With safety helmet**

Safety Glasses



Figure 152: **Incorrect practice - Normal glasses**

- Safety glasses are forms of protective eye wear that usually enclose or protect the area surrounding the eye in order to prevent particulates, chemicals from striking the eyes. Goggles are frequently worn when using power tools such as drills or chainsaws to prevent flying



Figure 153: **Correct practice - Safety glasses**

- particles from damaging the eyes.
- Sunglasses or regular glasses are not appropriate safety glasses.
- For employees who use spectacles they must use goggles that can fit comfortably over corrective eyeglasses without disturbing their alignment.

Face Shields



Figure 154: **Incorrect practice - Without face shield**

- A face shield should be worn whenever their entire face needs protection. Specialty face shields for arc flash, heat, radiation, and welding protection



Figure 155: **Correct practice - With face shield**

- are available as well. Safety glasses or goggles should always be worn under a face shield for maximum protection and safety.

Hand Gloves

- Tools and machines with a sharp edge can cut your hands. For electrical works, rubber insulating gloves are among the most important articles of personal protection. To be effective, electrical



Figure 156: **PVC Gloves**

safety gloves must include high dielectric and physical strength, along with flexibility and durability.

- Two kinds of gloves are commonly used: PVC Gloves and Cotton Gloves.



Figure 157: **Cotton Gloves**



Figure 158: **Incorrect practice - Without safety gloves**



Figure 159: **Correct practice - With safety gloves**

Safety belts/ Body harness

Safety belts or a harness provides the following support:

- Personal protection against falling from high structures.
- Enables comfortable working position with protection against imbalance and slipping.
- Climbing to a location that is inaccessible

from inside the building/household using an anchorage and suspension line.

- PVC coated jackets provide protection from extreme or harsh weather conditions, injury from sharp tools and chemicals or fluids that should not come in contact with the body.



Figure 160: **Incorrect practice - Without safety belts**



Figure 161: **Correct practice - With safety belts**

Safety Shoes



Figure 162: **Incorrect practice - Without safety shoes**



Figure 163: **Correct practice - With safety shoes**

- Safety shoes protects you from electrical shocks & burns, extreme heat, extreme moisture (can lead to fungal infections) and slipping (oil, water, soaps, wax, and other chemicals can cause you to slip and fall.)
- At work, heavy objects can fall on your feet. If you work around sharp objects, you can step on something sharp and

injure your foot.

- 3-4 active modules produce a dangerous voltage for a person touching exposed wires. Therefore, safety precautions need to be employed.
- If the inverter is disconnected from the modules or from the output AC side, high voltages remain may continue to exist.

Electrical Hazards



Risk to installers and maintenance personnel

- Specific electrical hazards are related to maintenance activities on the electrical parts of the PV plant. Specifically, during array connection during installation and replacement of PV panels there are potential electrocution hazards.
- The most common accidents are electrical

shocks and burns, contraction of muscles and other severe injuries. These injuries can take place at anytime if proper safety measures are not followed. It is difficult to estimate the severity of electrical injury because if the human body is exposed to a voltage, it acts like a resistor and allows the current to pass.

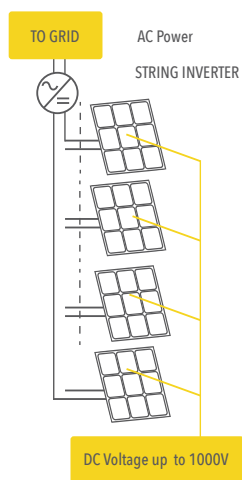

Figure 164: **AC power turned ON**

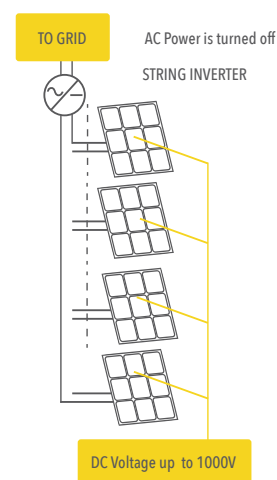

Figure 165: **AC power turned OFF**

Risk to firefighters

- False assumptions can lead to disasters. Firefighters commonly cut off electric grid supply to burning buildings as a precaution procedure before extinguishing the fire. They assume, that once the grid has been disconnected there is no risk of electrocution, allowing the spray of water.
- Unfortunately, this assumption is not true in case of a RTPV system. PV systems are always energized when exposed to sunlight. Traditionally, rooftop PV systems operate at up to 1,000 V DC (modern systems can even go as high as 1,500 V). Opening disconnects interrupts current flow. Hazardous voltages remain even with disconnects open.
- Always check the voltage between any conductor and any other wires, and to ground.
- Always wear gloves and avoid touching conductive parts (e.g., battery terminals, metal and mounting frames) with bare hands.
- Electric sparks and loose connection can lead to a fire. Take proper preventive measures:
 - Use insulated tools (e.g., spanners)
 - Ensure that the battery terminals are covered
 - Check contacts and voltage drop
 - Tighten up all screws
 - Check cable and terminal block periodically

The value of resistance varies with condition (Wet: 1,000 Ω - Dry: 100,000 Ω). Even a seemingly insignificant current (of order of mA) is also sufficient to cause damage. A list of DC and AC current (in mA) and their related electric shock hazards are given below:

Reaction after the Electric shock	Current	
	DC	AC
Perception: Tingle or warmth	6 mA	1 mA
Shock: Retain muscle control, response may result into injury and burns	9 mA	2 mA
Severe shock: Lose in muscle control, severe burns and asphyxia	90 mA	100mA
Ventricular Fibrillation: may cause death	500 mA	100mA
Heart Frozen: Temperature of human body rises, death occurs in minutes	>1 A	>1 A

Table 11: DC and AC current (in mA) and their related electric shock hazards

Chemical Hazards

Hydrogen is produced when a lead/acid battery is charged. Therefore, install battery in well-ventilated area and keep flames and equipment that create spark away from the battery.

A multipurpose extinguisher is a good choice. Use of CO2 operated fire extinguisher should be avoided because they extinguish fire by removing oxygen.

Fire Extinguishers category:

- **Class A:** For fires involving conventional combustible materials such as paper and wood.
- **Class B:** For fires involving flammable or combustible liquids or gases, greases and similar materials.
- **Class C:** For fires involving energized electrical equipment.
- **Class K:** For fires involving combustible metals.

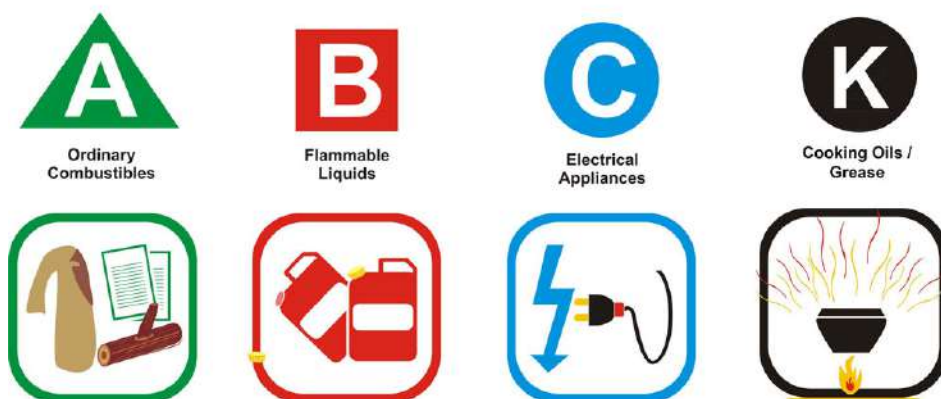

NOTE:
For fire caused by electrical equipment use a powder and CO2 fire extinguisher

Figure 166: Fire Extinguishers



KEY POINTS TO REMEMBER

While most construction jobs are within easy access to medical care, some construction jobs are in more remote areas. The following items should be considered when you develop procedures for responding to emergencies. Someone who is not on the jobsite should know the following:

1. How many people are on the jobsite?
2. Are they expected to return at a specific time?
3. Do they have access to a phone service?
4. Do employees have the proper safety training they need for the work they are doing?
5. Are they carrying a first-aid kit?
6. Is there a nearby hospital or clinic?
7. Do employees have proper safety gear in good working condition (such as fall protection and other personal protective equipment)?
8. Is employee emergency-contact information such as phone number, person to contact, and any pertinent medical information latest and accessible?
9. What is their emergency plan?



UNIT 6

READING YOUR ELECTRICITY BILL

WHAT WILL WE LEARN?

- Reading Electricity Bill and calculation of electrical energy consumption
- Effect on Electricity bill before installing solar and after installing solar

CALCULATING CONSUMPTION OF ELECTRICAL ENERGY

• It is very essential to understand the electricity bill and its components to plan for energy savings. Our electricity bills have quite a lot of information to give us a good insight to our electricity consumption patterns.

• Electricity consumption is noted in terms of kWh (kilowatt Hour) or units recorded by the electricity meter installed in your premise. A kilowatt-hour is equal to running an appliance of 1 kilowatt (or 1,000 Watts) for 1 hour.

$$\frac{(\text{Wattage} \times \text{hours of use})}{1000} = \text{kilowatt hour}$$

1 kWh = 1 Unit of Electricity

CONSUMPTION INFORMATION / વીજવપરાશની માહિતી							
Month	Jun-15	Aug-15	Oct-15	Dec-15	Feb-16	Apr-16	Jun-16
Unit	1072	620	598	416	356	637	1449

Figure 167: Electricity bill - Monthly units consumption

- A person from the utility (or DISCOM or distribution company) visits your premise at a selected frequency (in most states it is monthly, but in some states it is bimonthly or even quarterly) and records the reading on your meter.
- This meter reading is deducted from your previous meter reading to come up with the units consumed (or kWh consumed) for the period.
- The units consumed are then applied to a slab based tariff structure to come up with energy or electricity charges.
- Thus, it is very important that the person coming for meter reading is able to do his work accurately every time. In case you get into a situation where you find that there is some discrepancy in your reading, make sure to validate the meter reading before making the payment.

TARIFF STRUCTURE / વીજ દર				
Tariff વીજ દર	Units / Month માસિક યુનિટ	Rate/ Unit (₹) યુનિટ દર (₹)	Monthly Fixed Charges / installation (₹) માસિક ફિક્સ્ડ ચાર્જ / વીજ સ્થાપન (₹)	
			I Phase	III Phase
RGP Residential રહેઠાણ	First 50 units	3.20	25.00	65.00
	Next 150 units	3.90		
	Remaining Units	4.90		
BPL ગરીબી રેખા હેઠળ	First 30 units	1.50	5.00	5.00
	Next 20 units	3.20		
	Next 150 units	3.90		
	Remaining Units	4.90		
GLP ગ્રેડીએબલ ટ્રસ્ટ	First 200 units	4.10	30.00	70.00
	Remaining Units	4.80		
Tariff વીજ દર	Connected Load કનેક્ટેડ લોડ	Rate/ Unit (₹) યુનિટ દર (₹)	Monthly Fixed Charges / kW (₹) માસિક ફિક્સ્ડ ચાર્જ / કી.વો. (₹)	
Non-RGP રહેઠાણ સિવાય	Upto and including 5 kW	4.50	70.00	
	More than 5 kW & upto 15 kW	4.50	90.00	
Tariff વીજ દર		Rate/ Unit (₹) યુનિટ દર (₹)	Monthly Minimum Charges / BHP (₹) માસિક ન્યૂનતમ ચાર્જ / બીએચપી (₹)	
LTP-AG	Agricultural / ખેતીવાડી	3.30	10.00	

Figure 168: Electricity bill - Tariff Structure

CALCULATING ENERGY GENERATED BY MY RTPV SYSTEM



Summer

Plant Capacity = 1kW
 Sunshine hours = 5.5 hours/day
 Expected energy Generation:

$$5.5 \times 1 = 5.5$$



Monsoon

Plant Capacity = 1kW
 Sunshine hours = 3.5 hours/day
 Expected energy Generation:

$$3.5 \times 1 = 2.5$$



Winter

Plant Capacity = 1kW
 Sunshine hours = 4.5 hours/day
 Expected energy Generation:

$$4.5 \times 1 = 4.5$$

Therefore a customer can use the above thumb rule and can estimate the approximate energy generation in summer, winter and monsoon season.

NOTE:

- The available sunshine hours may vary based on installed site and climate conditions
- Customer must note their readings from SCADA system or by the Inverter display screen. If some large difference is found in the units then refer to the checklists for maintenance.

How much can I save after installing a rooftop solar system?

A very common question asked by customers who are keen to install a rooftop solar PV system is, "How much will I save after the installation"?

We explore this topic with an example of a 10 kW system

Customer Category	Residential
Sanctioned Load	10 kW
Average monthly consumption	429 kWh
Average monthly bill	Rs. 2,700
Installed System Capacity	5 kW

Table 12: **Site specifications**

What would be the performance of the PV system?

Now as a thumb rule solar PV plant of 1kWp will give you 4.5 - 5 units average per day per kW

Duration	System net generation: 5 units per day * Plant Capacity	Amount saved: Net energy generation* (Tariff Rate + Monthly Fixed charges + Government duty)
Daily	$5 * 5 \text{ kW} = 25 \text{ kWh per day}$	$25 * 6.50 = \text{Rs. } 163 \text{ per day}$
Monthly	$5 * 5 * 30 = 750 \text{ kWh per month}$	$750 * 6.50 = \text{Rs. } 4,875 \text{ per month}$
Yearly	$5 * 5 * 365 = 9125 \text{ kWh per year}$	$9125 * 6.50 = \text{Rs. } 59,315 \text{ per year}$

Table 13: **PV system net energy generation estimation**

How to calculate PV system performance?

The performance of a PV power plant is often specified by a metric called the capacity utilization factor. It is the ratio of the actual output from a solar plant over the year to the maximum possible output from it for a year under ideal conditions. Capacity utilization factor is usually expressed in percentage.

$$C.U.F = \frac{\text{Actual energy generation from the plant throughout the year(kWh)}}{\text{Plant Capacity (kWp)} \times 24 \times 365}$$

$$C.U.F = \frac{8,212.5}{5 \times 24 \times 365} = 18.75\%$$

Reading your bill - before and after the installation of a solar PV system

Before Installing Solar

YOUR ELECTRICITY BILL - Jun-2016

૨૪x૭ બીલ પેમેન્ટ સુવિધા (અમારા ગ્રાહક સુવિધા સેન્ટર ઉપર ઉપલબ્ધ)

Particulars / વિગત	Rupees
Total energy charges / કુલ વીજળીની રકમ (a + b + c + e)	8703.80
Govt duty / સરકારી કર (d)	1296.58
Current bill amount / હાલના બીલની રકમ	10000.38
Previous Dues / અગાઉના લેણાં	114.24CR
Gross amount / કુલ રકમ	9886.14

Payment received online/ through ECS Rs. 4210.00
 ઇ.સી.એસ. ટ્રાન્સ / આન-ચાર્જ મેળવેલ પેમેન્ટ રૂ.

e-Bill

* For your convenience, the bill has been rounded down to Rs. 10/- Adjusted amount will be reflected in your next energy bill.
 To pay your bills online visit <https://connect.torrentpower.com>

METER & BILLING DETAILS / મીટર અને બિલ ની વિગત

Meter No.	1793803
Present reading / હાલનું વાંચન	44080
Past reading / અગાઉનું વાંચન	42631
Multiplying factor / ભટ્ટીપલાઈન ફેક્ટર	1.00
Units consumed / વપરાયેલા ઝુલિંટ	1449
a) Energy charges / વીજળીની રકમ (Rs).	6630.10
b) FPPPA charges / જીવલેલ એડ્જ. ચાર્જ (Rs).	1883.70
c) Fixed charges / ફીક્સ ચાર્જ (Rs).	130.00
d) Govt duty / સરકારી કર (Rs).	1296.58
e) Meter rent / મીટર ભાડુ (Rs).	60.00

CONSUMPTION INFORMATION / વીજવપરાશની માહિતી

Month	Jun-15	Aug-15	Oct-15	Dec-15	Feb-16	Apr-16	Jun-16
Unit	1072	620	598	416	356	637	1449

SECURITY DEPOSIT INTEREST CREDITED IN PREVIOUS DUES 119.00-

PAYMENT OF RS. 20,000 AND ABOVE OF REGULAR ENERGY BILLS WILL BE ACCEPTED BY CHEQUE/PAY ORDER/DEMAND DRAFT

Amount Due / ભરવાપાત્ર રકમ

Rs. 9880.00*

Bill Due date / બિલ ભરવાની છેલ્લી તારીખ

07-07-16

Category / પ્રકાર	Residential
Sanctioned Load / અધિકૃત વીજભાર	6.880 KW
Security Deposit / Rs. સિન્ડ્રિટી ડિપોઝિટ	1400
Reading Date / વાંચનની તારીખ	15-06-16
Bill Date / બિલની તારીખ	21-06-16
Billing Mode / બિલને આવરી લેતા દિવસો	60 days
FPPPA rate per unit in Ps. જીવલેલ એડ્જ. ચાર્જ્સ પ્રતિ ઝુલિંટ (પેસા)	130

ટોરેન્ટ પાવર મોબાઈલ લીક વેબ :

તારીખ : ૧, ૨, જુલાઈ
 સવારે ૮-૩૦ થી ૧૩-૩૦ - સાંજે ૧૫-૩૦ થી ૧૯-૦૦
 શાનદા સોસાયટી, અમુલ ગાર્ડન પાસે, જાવરાજ પાર્ક

તારીખ : ૩, જુલાઈ - સવારે ૮-૩૦ થી ૧૩-૩૦
 શાનદા સોસાયટી, અમુલ ગાર્ડન પાસે, જાવરાજ પાર્ક

તારીખ : ૪, જુલાઈ
 સવારે ૮-૩૦ થી ૧૩-૩૦ - સાંજે ૧૫-૩૦ થી ૧૯-૦૦
 ૧, શ્રીનંદનગર

૨, ટીવી ૯ બોક્સ પાસે, જાવરાજ પાર્ક

તારીખ : ૫, ૬, જુલાઈ
 સવારે ૮-૩૦ થી ૧૩-૩૦ - સાંજે ૧૫-૩૦ થી ૧૯-૦૦
 જલદરંગ બસ સ્ટેન્ડ પાસે, વેજલપુર રોડ

તારીખ : ૫, ૬, ૭, જુલાઈ
 સવારે ૮-૩૦ થી ૧૩-૩૦ - સાંજે ૧૫-૩૦ થી ૧૯-૦૦
 શ્રીનંદનગર

Figure 169: Electricity Bill- Before installing solar



Here is an example of an electricity bill:

After Installing Solar

CATEGORY प्रकार	SANCTIONED LOAD अधिकृत वीजभार	SUPPLY TYPE पुरवठा नों प्रकार	READING DATE वांचननी तारीख
Residential	10.000 KW	3-PH	15-06-17

Meter No. मीटर नं	Present Reading हावुं वांचन	Past Reading अगाउनुं वांचन	Multiplier गुणक	Units Registered नोंधायेव युनिट
(A) 6909601	2086	- 907	x 1.00	= 1179
(B) SOLAR-EX	3133	- 2273	x 1.00	= 860
Net Units Billed				319

BILL DETAILS / बिब नी विगत (₹)		(A)
Energy Charges / वीज नी रकम		1174.10
FPPPA Charges / क्युअल ओउर. यार्जस		405.13
Regulatory Charge / रेगुलेटरी चार्ज		51.66
Fixed Charges / फीकस यार्जस		130.00
Govt Duty / सरकारी कर @ 15.00%		264.14
Meter Rent / मीटर भाडु		20.00
Total Energy Charges Without Govt. Duty / कुल वीज नी रकम सरकारी कर सिवाय		1780.89
Total Govt Duty / कुल सरकारी कर		264.14
Current Bill Amount / हावना बिबनी रकम		2045.03
Previous Dues / अगाउना वेणुं		3975.14CR
Other Debit or Credit / अन्य वेणुं अथवा ढमा		0.00
Delayed Payment Charges / विवंध माटे युक्ववापात्र रकम		0.00
Amount Due / भरवापात्र रकम		1930.11CR

 BILLING MONTH बिब मदिनो	Jun-2017
 DUE DATE छेव्वी तारीख	04-07-17

₹ AMOUNT DUE / भरवापात्र रकम
1930.00CR*

PREVIOUS PAYMENT RECEIVED
AMOUNT : ₹ 2770.00 DATE : 31-12-16

SAVE Energy saving tips

- Run air conditioner optimally at 24°
- Set thermostat to medium-cooling position
- Don't leave TV in stand by mode, Switch OFF completely
- Ensure adequate space between refrigerator and wall. Do not open the door frequently.

SECURITY DEPOSIT HELD **6000.00**
ढमा डीपोजीट रकम

ADDL SECURITY DEPOSIT REQD **1078.00**
वधारांनी युक्ववापात्र डीपोजीट रकम

FPPPA RATE (PS-PER UNIT) **127**
क्युअल ओउर. दर (पैसा-प्रति युनिट)

REGULATORY CHARGE (PS-PER UNIT) **18****
रेगुलेटरी चार्ज (पैसा-प्रति युनिट)

Figure 170: Electricity Bill- After installing solar

The right hand corner of the bill contains the amount to be paid to the discom (Rs.9,880). You will notice that there is no mention of net metering of solar PV system.

NOTE:

The customer has extended the load from 6 kW to 10 kW before installation of Solar PV power plant.

Here is an example of the electricity bill once a rooftop solar system has been installed. There are a few key changes:

 METER DETAILS / મીટર ની વિગત							
Meter No. મીટર નં	Present Reading હાલનું વાંચન	-	Past Reading અગાઉનું વાંચન	x	Multiplier ગુણક	=	Units Registered નોંધાયેલ યુનિટ
(A) 6909601	2086	-	907	x	1.00	=	1179
(B) SOLAR-EX	3133	-	2273	x	1.00	=	860
Net Units Billed							319

Figure 171: **Electricity Bill - Units consumption**

Number one, the meter details show a separate row (SOLAR-EX). This indicates the number of units that have been exported into the grid.

The row A shows the existing consumption as recorded by the consumption meter. The difference between the two i.e A-B gives the

net units to be billed (319 units). Going into the bill details, one notices that while the total energy charges without Govt. Duty is Rs. 1,780.89, there is a credit from the previous billing cycle (Rs. 3,975.14), which ensures that the net bill is Rs. 1,930. This amount is carried over to the next billing cycle.



UNIT 7

Documentation

Documentation plays a significant role in understanding system components (model no, warranty, user manual, contact details, safety etc.). In RTPV systems there is no qualified person always available on site therefore, access to information especially useful during O&M. For instance, if the inverter needs to be replaced, one requires the warranty information, model number, datasheets etc. All information is available at one place, in case of an emergency the customer should have an easily accessible ready reference that gives all information about the system.

IMPORTANCE OF DOCUMENTATION & ITS SIGNIFICANCE

- System Documentation
- Component Documentation
- Maintenance Documentation

Various technical documentation and drawings are required at different stages of inspection and operation & maintenance of the PV system.

System Documentation

It covers all the documents that gives the basic overview of the rooftop solar PV system.

S.no.	Document	Purpose
1.	System description diagram	<ul style="list-style-type: none"> • It gives the basic overview of understanding the basic system framework.
2.	Equipment layout diagram/ Interconnection	<ul style="list-style-type: none"> • Indicates the physical layouts including dimensions of the rooftop/ terrace as well as location of each equipment such as PV modules, inverters, DC and AC junction boxes, transformers (if applicable), etc. with clear identification and labeling of each equipment. This diagram covers the physical aspects of the installation. • It must be properly labeled so that the location of any string or module can be easily identified. • It is useful if any engineer or technician arrives for maintenance or troubleshooting.

S.no.	Document	Purpose
3.	Wire and earthing layout diagram	<ul style="list-style-type: none"> • It appears similar to the equipment layout diagram, but indicates the electrical interconnections including PV modules, junction boxes, inverters, transformers (if applicable), Disconnecter and various equipment, up to the interconnection or meter. In addition, this drawing also indicates the earthing interconnection scheme for various DC and AC equipment and lightning arrestor, while also clearly showing the location of the earth pits. • It is useful if any engineer or technician arrives for maintenance or troubleshooting.
4.	Single Line Diagram (SLD)	<ul style="list-style-type: none"> • Indicates the electrical configuration of the PV system with key specifications of various components. • It is useful if any engineer or technician arrives for maintenance or troubleshooting.
5.	Generation estimation report	<ul style="list-style-type: none"> • Based on historical meteorological data and expected plant losses and performance parameters. Such reports can be developed manually, or using software such as PVsyst or PVSOL.

Please refer to annexure I

Maintenance Documentation

It covers all the documents which gives details of the service provider. It is very essential to get a service/replacement when a product malfunctions.

S.no.	Document	Purpose
1.	Service documentation	<ul style="list-style-type: none"> • Invoice of O&M Service provider • Service contract must include: At what intervals the scheduled maintenance will be performed? What kind of services will be included in the maintenance contract? What will be the response time when there is service outage? What sort of system problem will incur the additional cost for the customer? • It is very essential to ensure the right level of service is received.
2.	Contact Information	<ul style="list-style-type: none"> • Various stake holders such as installer, project developer, EPC contractor, designer, lending agency etc. • O&M Service provider

Please refer to annexure II

Component Documentation

It covers all the documents which gives details of all components. It is very essential to get a replacement when a product malfunctions.

S.no.	Document	Purpose
1.	Component Datasheets	<ul style="list-style-type: none"> • Containing datasheets of the PV modules, inverters, transformers (if applicable), DC and AC junction boxes, DC and AC cables, DC cable connectors, earthing cable, lightning arrestor, surge protection devices, Disconnecter/ isolators, earth pit, monitoring system (if applicable) and energy meter • Datasheets will provide all the details of your product. • It is useful if any engineer or technician arrives for maintenance or troubleshooting.
2.	Warranty Certificates	<ul style="list-style-type: none"> • Containing warranty certificates of the PV modules, inverters, transformers (if applicable), lightning arrestor (if applicable), etc. by the Original Equipment Manufacturer (OEM). • It is very essential to get a replacement when a product malfunctions.
3.	Other Certificates	<ul style="list-style-type: none"> • IEC and other certificates for PV modules & Inverters • Containing test certificates of PV Modules so that the quality of each individual module is maintained. • Essential for safety purpose also.
4.	Invoices of all products	<ul style="list-style-type: none"> • Contains bills of all the products purchased • It is very essential to get a replacement when a product malfunctions.

DIRECTORY

Gujarat

AAPLUG TECHNOLOGY



 07434066394
 07434066395/6
 info@solarrooftop.co.in
 Nilesh Talaviya (Founder)
 41, Ram Nagar, Nr Rashi Circle,
 Laxmikant Aashram Road,
 Katargam, Surat-4

DISHACHI SOLAR TRAINING INSTITUTE



 +91 9033127700
 +91 9898762600
 dstisurat@gmail.com
 24,25,26,FF ,Punitdham soc,
 Maruti Chowk,Near Lajamni,
 MotaVarachha,Surat-394101



ADDIN POWER LIMITED



 +91 8155009413
 079-40027017
 info@addinpower.com
 Addin Power Limited, SF-202,
 A-Wing, Narnarayan Complex,
 Nr. Navrangpura Bus Terminal,
 Nr Swastik Cross Road,
 Navrangpura, Beside C.G. Road,
 Ahmedabad - 380009

ENERGY ASSET SOLUTIONS PVT LTD.



 +91 9825098956
 ashutosh@energyasset.in
 office Address: 809 Parshawnath
 Business Park, Nr Prahladnagar
 Garden, Prahladnagar,
 Ahmedabad 382443



ADEPT RENEWABLE ENERGY



 Bharat B. Patel
 +91 9924567555
 bpatel@adeptcorporation.com
 info@adeptcorporation.com
 www.adeptcorporation.com
 11 Garden View, ECS House
 Opp AUDA Garden, Nr. Global
 Hospital Bodakdev, Ahmedabad
 380054 Gujarat

EVOTAR TECHNOLOGIES PVT LTD



 Yash Bhatt
 +91 9426335145
 yash.bhatt@evotartech.com
 20, Sukrut Industrial Estate,
 Memco Char Rasta, Naroda
 Road, Ahmedabad, Gujarat
 380025

DISHACHI ENERGY



 +91 9898762600
 +91 9099912612
 info@dishachienery.in
 24,Anand vatika shopping ,
 near haveli ,setelite road ,mota
 varachha-surat -394101

GUPTA INDUSTRIAL MAINTENANACE SERVICES PVT LTD



 Yash Gupta
 +91 9879806111
 yash@gimsindia.com
 Chankya Complex,3rd Floor,
 VAniyavad Circle, College Road,
 College Rd, Chalali, Nadiad,
 Gujarat 387001

KANODA ENERGY SYSTEMS PVT. LTD



☎ 1800 843 3800
 ✉ info@kanoda.com
 📍 501, Sheraton House, Opp. Ketav Petrol Pump, Panchvati Road, Ambavadi, Ahmedabad, Gujarat - 380 015

TATVA POWER PROJECTS AND ASSOCIATES MEP & SOLAR CONSULTANTS



☎ +91 80 2225 8293
 ✉ info@companyname.com
 📍 Reg. Address : 19, Ratneshwari Society; Ranip, Ahmedabad - 382480 Gujarat

LAKSH SOLAR



☎ +91 7359899919
 +91 7096104919
 +91 7359199919
 ✉ info@lakshsolar.com
 info_surat@lakshsolar.com
 info_anand@lakshsolar.com
 📍 102, Laksh Solar, Laksh Prime Complex, Opp. Town Hall, Anand-388001, Gujarat

TECHNOGOODS ENTERPRISES



☎ +91 9904709693
 +91 9904709695
 ✉ technogoods@outlook.com
 www.technogoodsindia.com
 📍 TechnoGoods Enterprises, 40, Shantikunj, Vadtal Road, Bakrol, Anand- 388315, Gujarat

MARUTI ELECTRICALS



☎ Love Patel
 +91 9727474683
 ✉ marutielectricals2016@gmail.com
 📍 C/14, Sola Mrudul Park Society, Part-2, Nr Satadhar Cross Road, Sola Road, Ahmedabad- 380061

TOPSUN ENERGY LIMITED



☎ 079-232-888-04
 079-232-888-05
 ✉ Info@topsunenergy.com
 marketing@topsunenergy.com
 📍 B-101, GIDC, Electronic Zone, Sector-25, Gandhinagar-382028, Gujarat

SHASHWAT CLEANTECH PVT. LTD.



☎ Mr.Karan Dangyach
 +91 9825060546
 079-40022224
 ✉ karan@shashwatcleantech.com,
 info@shashwatcleantech.com, , bd@shashwatcleantech.com
 📍 A-7, First Floor, Safal Profitaire,, Corporate Rd, Prahlad Nagar, Ahmedabad, Gujarat 380015

DIRECTORY

Delhi

GREEN SOLARWALE INDIA PVT. LTD. "THE SOLARWALE"



+91 9999060699

info@thesolarwale.com
www.thesolarwale.com

Green Solarwale India Pvt. Ltd.
2057, Swaran Park Industrial
Area, Mundka, Delhi - 110041

Tamil Nadu

GOGGLES ENERGY PVT. LTD.



+91 7708108158

enquiry@gogglesenergy.com
www.gogglesenergy.com

Goggles Energy Pvt. Ltd.,
c/o Indo German Chamber of
Commerce, No.32 G.N Chetty
Road, T. Nagar,
Chennai - 600017

SOLARSMITH ENERGY (P.) LTD.



+91 99583 87486
+91 99583 87459

Sales@SolarSmiths.com
www.SolarSmiths.com

K-64, Udyog Nagar, Rohtak
Road, New Delhi- 110041

Maharashtra

TATA POWER SKILL DEVELOPMENT INSTITUTE (TPSDI)



+91 9223582855
022 67172182

tpsdi-customer@tatapower.com

TPSDI, Kalyan Murbad Road,
Post Office: VARAP, Near Hotel
Red Chilli, Shahad-421301,
Maharashtra



LIST OF FIGURES

Figure 1	Stand-alone system with both DC & AC loads	22
Figure 2	Stand-alone system with only DC loads	22
Figure 3	Grid connected PV System	23
Figure 4	Hybrid PV System	23
Figure 5	Photovoltaic Modules	24
Figure 6	Series and Parallel connection of PV Modules	25
Figure 7	DC Cables	25
Figure 8	Strings Junction (SJB)	26
Figure 9	DC Isolators	26
Figure 10	Isolation Transformer	27
Figure 11	Inverter	28
Figure 12	AC Distribution Box	29
Figure 13	AC Cables	29
Figure 14	Module Mounting Structures	30
Figure 15	Lightning Arrestor	30
Figure 16	Earth Pit	31
Figure 17	Charge Controller	31
Figure 18	Battery	32
Figure 19	O&M Approaches	34
Figure 20	Digital Multimeter	40
Figure 21	Clamp Meter	41
Figure 22	Thermography Camera	42
Figure 23	Cleaned Modules	50
Figure 24	Cleaning required shortly (no significant financial impact)	50
Figure 25	Cleaning required (significant financial impact)	50
Figure 26	Modules being used to dry chilies	52

Figure 27	Shading on PV modules due to surrounding objects	52
Figure 28	String of series connected solar cells having one shaded or mismatched cell	53
Figure 29	Shows the partial shading on a residential installation	54
Figure 30	Power loss due to shading on modules	54
Figure 31	Two modules - one of monocrystalline and the other polycrystalline technology installed in the same system	56
Figure 32	Datasheet of TITAN M6-60 PV Module	57
Figure 33	Moisture Condensation	57
Figure 34	Tiny hairline cracks	57
Figure 35	Corrosion	57
Figure 36	Delamination	57
Figure 37	Wet Cleaning (Manual)	59
Figure 38	Damaged Module	60
Figure 39	Never climb on modules	60
Figure 40	Never sit or stand on PV modules	60
Figure 41	Dirt Build-up due to wrong cleaning practices and Quality of water	61
Figure 42	Dry Cleaning Method (Manual)	62
Figure 43	Cleaning Equipment	63
Figure 44	Wet cleaning using robotic method	64
Figure 45	Wet cleaning using an automated system	64
Figure 46	Dry cleaning method using an automated system	65
Figure 47	Tree grows adjacent to your PV system and casts its shadow on modules	68
Figure 48	Nearby module casts a shadow on another module	68
Figure 49	Building gets constructed near your mounting structure	69
Figure 50	Shading due to drying crops	69
Figure 51	Shading due to nearby poles on terrace	70
Figure 52	Shading due to human activity and other obstructions	70
Figure 53	Effect of core shadow and partial shadow on modules	71
Figure 54	Solar Pathfinder leveler adjustment	72
Figure 55	Solar Pathfinder indicating latitude location	72
Figure 56	Solar Pathfinder arcs indicating time and months	73
Figure 57	Dome shaped cover of solar pathfinder for shadow analysis	73
Figure 58	Location of Bypass Diode on PV Module	74
Figure 59	Bypass diode inside Junction Box	74
Figure 60	72-cell PV circuit - A bypass diode is typically installed in parallel with every 24 cell	75

Figure 61	Voltage measurement	76
Figure 62	Current measurement	76
Figure 63	Thermography images under normal operation	79
Figure 64	Thermography images showing unusual hotspots	79
Figure 65	Standalone Inverter	87
Figure 66	Grid connected inverter	88
Figure 67	Grid interactive inverter	88
Figure 68	Hybrid Inverter	89
Figure 69	Central inverter	89
Figure 70	Central inverter internal structure	89
Figure 71	String Inverter	90
Figure 72	Demonstration of Micro Inverter	90
Figure 73	Demonstration of Power Optimizer	91
Figure 74	Switch off inverter before performing any maintenance	92
Figure 75	Wrong connection from main distribution box at customer's residence	92
Figure 76	Correct connection from main distribution box at customer's residence	93
Figure 77	Correct connection from main distribution box to sub distribution box at customer's residence	93
Figure 78	Note readings from inverter display screen	94
Figure 79	LED Green - Indicating correct operation of inverter	94
Figure 80	LED Red - Indicating incorrect operation of inverter	94
Figure 81	Inverter damage - Burn out	94
Figure 82	Inverter base sealed properly	94
Figure 83	Disconnected wire from inverter base	95
Figure 84	Inverter installed without any shade or roof	95
Figure 85	Inverter installed under shade	95
Figure 86	Inverter cables and conduits got loosed	95
Figure 87	Inverter ventilation room	96
Figure 88	Dust accumulation on Inverter	96
Figure 89	Cleaning inverter using blower	96
Figure 90	Check insulated gate bipolar transistors for discoloration	97
Figure 91	Inverter display screen	97
Figure 92	Check inverter fuses	97
Figure 93	Inverter grounding levels	98
Figure 94	Written inspection report of Inverter	98

Figure 95	Overcurrent protection devices (OCPDs)	112
Figure 96	Block diagram of PV System indicating location of disconnects	113
Figure 97	Fuses	113
Figure 98	Blown fuse	114
Figure 99	Battery sulfation	116
Figure 100	Incorrect cable routing	117
Figure 101	Proper cable routing	117
Figure 102	Incorrect cables connection - Looped tightly	118
Figure 103	Incorrect cables connection - Looped loosely	118
Figure 104	Correct cabling connection	118
Figure 105	Properly insulated	118
Figure 106	Improper insulation	118
Figure 107	Incorrect - Cable conduit are not closed	119
Figure 108	Correct- Cable conduit are closed	119
Figure 109	Incorrect - Conduits are damaged	119
Figure 110	Correct - Conduits are in proper condition	119
Figure 111	Cables are labelled properly	120
Figure 112	Cables are not labelled properly	120
Figure 113	Cables are tied using cable tie	120
Figure 114	Proper choice of fuses - Note ac and dc rating of fuses	121
Figure 115	Good Installation	122
Figure 116	Bad Installation	122
Figure 117	Rusting of Mounting structure	122
Figure 118	Loosed clamps	122
Figure 119	Tilt angle of PV Modules	123
Figure 120	Fuses - Burnt out	124
Figure 121	Grounding	124
Figure 122	No Equipment Grounding	126
Figure 123	Proper Equipment Grounding	126
Figure 124	Poor Lightning Protection	127
Figure 125	Good Lightning Protection	127
Figure 126	Proper condition of battery	128
Figure 127	Improper condition of battery	128
Figure 128	Refilling battery	128
Figure 129	Improper and proper battery terminals	129
Figure 130	Battery cleaning using baking soda	130
Figure 131	Tightened battery terminals	130

Figure 132	Charge controller	132
Figure 133	SCADA - Displaying the daily energy generation of PV System	133
Figure 134	SCADA - Displaying the daily power generation of PV System	134
Figure 135	SCADA - Displaying units consumed for self-use and exported to grid	134
Figure 136	Inverter display screen showing units generated by PV system	135
Figure 137	Net metering display screen showing units consumed by consumer	137
Figure 138	Continuity test	137
Figure 139	Insulation test	138
Figure 140	Testing using clamp meter	138
Figure 141	Connect test cables	138
Figure 142	Select the appropriate ohm's rating	139
Figure 143	Fuse testing using Multimeter	139
Figure 144	Display indicating Good and Blown fuse	
Figure 145	Cable continuity test	140
Figure 146	Earthing & Lightning Protection testing methods & techniques	140
Figure 147	Battery Load test using Multimeter	141
Figure 148	Insulated tool kit	149
Figure 149	Site safety	150
Figure 150	Incorrect practice - Without safety helmet	152
Figure 151	Correct practice - With safety helmet	152
Figure 152	Incorrect practice - Normal glasses	153
Figure 153	Correct practice - Safety glasses	153
Figure 154	Incorrect practice - Without face shield	153
Figure 155	Correct practice - With face shield	153
Figure 156	PVC Gloves	154
Figure 157	Cotton Gloves	154
Figure 158	Incorrect practice - Without safety gloves	154
Figure 159	Correct practice - With safety gloves	154
Figure 160	Incorrect practice - Without safety belts	155
Figure 161	Correct practice - With safety belts	155
Figure 162	Incorrect practice - Without safety shoes	155
Figure 163	Correct practice - With safety shoes	155
Figure 164	AC power turned ON	156

Figure 165	AC power turned OFF	156
Figure 166	Fire Extinguishers	157
Figure 167	Electricity bill - Monthly units consumption	162
Figure 168	Electricity bill - Tariff Structure	162
Figure 169	Electricity Bill- Before installing solar	165
Figure 170	Electricity Bill- After installing solar	166
Figure 171	Electricity Bill - Units consumption	167



LIST OF TABLES

Table 1	Effect of dust on PV Modules	51
Table 2	Financial analysis of dust on PV Modules	51
Table 3	Financial analysis of shading on PV Modules	55
Table 4	Module voltage and current readings	77
Table 5	Analytical data of a PV Module	77
Table 6	Voltage and Current readings of PV Modules connected in series and parallel	77
Table 7	Frequency of doing PV Modules maintenance work	81
Table 8	Financial analysis of blown fuse	115
Table 9	Typical Battery voltages as function of state of charge	142
Table 10	Voc and corresponding SOC for deep cycle lead acid batteries during a load test	142
Table 11	DC and AC current (in mA) and their related electric shock hazards	157
Table 12	Site specifications	164
Table 13	PV system net energy generation estimation	164

ANNEXURE I

Installer & Warranty Information Checklist

A. Basic Information

Company Name	
Name of the Contact Person	
Designation of Contact Person	
Mobile number of Contact Person	
Landline number of Contact Person	
E-mail Address of the contact Person	
Company Website	
Company Local Address	
Has the Company provided warranty on the equipment and installation with appropriate documents? Please check those that are applicable and fill the details.	<input type="checkbox"/> PV Module Performance: _____ Years <input type="checkbox"/> Module Workmanship: _____ Years <input type="checkbox"/> Inverter: _____ Years <input type="checkbox"/> Battery: _____ Years <input type="checkbox"/> Overall Installation: _____ Years <input type="checkbox"/> Others, Please Specify: _____
Is the Company providing maintenance Service?	<input type="checkbox"/> No <input type="checkbox"/> Yes, for _____ Years If Yes, please specify nature of Service.

B. Owner's Documentation

- Owner's manual
- Basic system operation circuit diagram
- Manufacturer's warranty
- Compliance with standard certificates
- Permits from the building and electricity authorities
- System disconnect sequence and safety procedures
- Operation and Maintenance instructions
- Emergency contact information for Maintenance

C. System Installation

Electrical

- Equipment must be correctly selected without any damage and must be compliant with standards
- All the components must be correctly connected
- Equipment placing must be appropriate, it must be accessible for inspection, operation & maintenance
- Protective measures must be taken for special location (more sunshine, cloudy) etc.
- Conductor selection must be appropriate (sunlight resistant and wet rated)
- Cabling must be done neat and secure
- Proper insulation on module wiring and proper wiring sizes

Mechanical

- Each component must be installed as per plans- the model number, Standards etc.
- If roof mounted ensure that the roof is capable of handling additional weight of PV system
- Proper ventilation must be provided behind array to prevent overheating
- Array frame must be correctly fixed and material must be corrosion free
- For rooftop systems the mounting must be secure and weather tight
- Cable entry must be weatherproof
- Proper grounding of the system parts to reduce the threat of shock hazard and induced surges
- Aluminium should not be placed in direct contact with concrete
- Dissimilar metals must be electrically isolated to avoid galvanic corrosion
- Ensure the design meets the local utility interconnection requirements

D. Component Installation

- Array installation must be neat and permanent
- For protection against electric shock surge protection devices must be installed accurately
- Modules must be installed in a shading free area
- Each string or module must have a protecting over current device
- Equipotential bonding must be present in an array frame
- System grounding and Equipment grounding must be done correctly
- Wiring must be done with shortest distance from PV panels to inverter
- Fuses must be capable of being changed without touching any live contacts
- Separation of D.C. and A.C. cables
- Conductors must not be in contact with roof
- Conduit must be supported properly
- All components must be rated for operation at max. D.C. system voltage

- Batteries must be installed in well ventilated areas
- Labeling of components, circuits, Protection devices, cables and switches must be properly done
- Installer details must be displayed on site & Labels must be properly visible and durable
- Protection setting must be displayed on site
- Emergency shutdown procedure must be displayed on site

E. DC & AC Cabling connections

- Check for cable condition wear and tear
- Check for DC and AC cables should be installed in separate conduits or enclosures and properly labelled
- Check cable terminals for burnt marks, insulation, hotspots or loose connections
- Check for corrosion
- Check the bending radius of cables
- Cables should stay away from lightning conductors
- All the terminations should use proper terminals, no cable to cable joints to be used
- Cables, cable ties and fasteners should be weather resistant
- Cables should be laid in shadow areas wherever possible and they should not impede rain water runoff

F. Grounding Considerations

- Proper equipment and system grounding is required :
 - To provide earth as common reference point for various voltages
 - To limit voltages due to lightning
 - Line surges
 - Accidental contact with high voltage lines and
 - To provide current path for operation of overcurrent protection devices
- Array support structure should have equipotential bonding and grounding arrangements for safe conduction of captive discharge current to ground

G. Certification by Applicant

- I am duly authorised person to file this application on behalf of my premises and/ or organization.
- I / my Organization is duly authorized to utilize the intended rooftop/ terrace for solar energy generation through the rooftop solar PV system for which interconnection is sought in this application.
- All information provided herein is true to the best of my knowledge, and that any deviation, identified now or later, may lead to the disqualification of this application and even dismantling of the rooftop PV system thereof.

- I am duly authorised person to file this application on behalf of my premises and/ or organization.

I / my Organization is duly authorized to utilize the intended rooftop/ terrace for solar energy generation through the rooftop solar PV system for which interconnection is sought in this application.

All information provided herein is true to the best of my knowledge, and that any deviation, identified now or later, may lead to the disqualification of this application and even dismantling of the rooftop PV system thereof.

I will abide by all terms and conditions as stipulated by [name of the Distribution Licensee] towards interconnection and operation of the rooftop PV system, as amended from time to time.

Place: _____

Date: _____



Seal & Signature

Name :

(* Note: Other/ if applicable. In case of more information, please add as attachments.)

ANNEXURE II

Maintenance Checklist

A. Basic Information of Company

Company Name	
Name of the Contact Person	
Designation of Contact Person	
Mobile number of Contact Person	
Landline number of Contact Person	
E-mail Address of the contact Person	
Company Website	
Company Local Address	

B. Basic Information of Plant

Date of Inspection & Maintenance	
Plant Capacity	

C. Module & Array Inspection

- Module Condition - [] Module Cleaning, [] Damage of Module, [] Dirt Accumulation
- Check Shading observed on Modules.
- Inspect a subset of array top glass inspection - look for Blemishes, spots, bonding of frame to glass and discoloration.
- Back sheet inspection - look for spots, Blisters burn through, Discoloration.
- Check for Insulation on module wiring.
- Proper wire condition and sizing.
- Check for connectors on array wiring extensions.
- Inspect module Junction boxes - look for sealants, proper wire management.
- Check for proper grounding of array and array mount.
- Inspect module clamping methodology - check for loose fasteners, secured and sealed properly.
- Perform thermal scan of modules and note any discrepancies
- Check for Proper Labelling
- Visually check array - if broken, damaged or loose module, loose racking hardware, wiring and MC4 connectors. Visually inspect all supporting parts- corrosion/evidence of rust, when encountered apply the cold galvanization spray.

- Module Condition - [] Module Cleaning, [] Damage of Module, [] Dirt Accumulation
- Check Shading observed on Modules.
Inspect a subset of array top glass inspection - look for Blemishes, spots,
- bonding of frame to glass and discoloration.
Back sheet inspection - look for spots, Blisters burn through, Discoloration.
- Check for Insulation on module wiring.
Proper wire condition and sizing.
- Check for connectors on array wiring extensions.
Inspect module Junction boxes - look for sealants, proper wire management.
- Check for proper grounding of array and array mount.
Inspect module clamping methodology - check for loose fasteners, secured and
- sealed properly.
- Perform thermal scan of modules and note any discrepancies
- Check for Proper Labelling
Visually check array - if broken, damaged or loose module, loose racking
- hardware, wiring and MC4 connectors. Visually inspect all supporting parts-
- corrosion/evidence of rust, when encountered apply the cold galvanization spray.
- Verify proper operation of dc disconnections. Measure output circuit conductor to see if any combiner box is reading low.
- Measure output current of each combiner box on single string, if low check for all strings
- Visually check all D.C disconnections and combiners - corrosion, blown fuses, moisture entry, heat distortion, insect or rodent issues.
- Check all duct seals, gaskets and other sealing methodologies are fully intact and functional. Repair or replace if necessary.
- Inspect wire, conduits, piping, tighten all electrical connections and correct if any issue is identified.
- Check for ground continuity between the frames and racking structure.
- Check for continuity of cable to electrical earth.
- Check for corrosion - copper wires, PV frames and galvanized steel racking structure
- For Ballasted system, verify ballasted material is not degraded.
- For folded rack sites, verify wind deflectors are firmly attached to racking structure.
- Inspect array for build-up of debris underneath, clean whenever necessary.
- Check for labelling.

D. Combiner Box

- Measure the current in each string, if found zero then check the fuse (replace if necessary)
- Check for any damages of cabinet or enclosures.
- Check for deposition of any dirt or dust.
- Check out for wear out screws or handle of enclosure and support structure.
- Check for any loose connections or tightness of the terminations.
- Check for heating, hardening of cables and change in colour of the components of the combiner box.
- Proper wire condition, sizing and insulation.
- Check for proper labelling.
- Check for proper functioning of the MCB, MCCB, Disconnect switch and diodes.

E. Charge Controllers (Battery Backup systems only)

- Check for any damages of cabinet or enclosures.
- Check for proper wire condition, sizing and insulation.
- Check for deposition of any dirt or dust.
- Check for proper labelling.
- Input and output disconnects labelled.
- Check for proper grounding.

F. Batteries (Battery Backup systems only)

- Proper ventilation for cooling.
- Check the terminals protected from shorting.
- Check for proper wire condition, sizing and insulation and burnt marks if any.
- Check for deposition of any dirt or dust.
- Check for electrolyte leaks and cracks in cells.
- Check for corrosion at terminals, connectors, racks and cabinets.
- Check for ambient temperature (all cells must be at same ambient temperature).
- Flooded vented to outside.
- Check for proper labelling.
- Check for proper wire condition, sizing and insulation

G. Inverter

- Visually inspect inverter for external damage
- Check the functionality of inverter
- Check that the installation is neat and permanent
- Check inverter display and record all input and output voltages
- Clean area around inverter and verify base is sealed
- Shut down A.C/D.C breakers to inverter, power down the inverter
- Wait for inverter to discharge (approx. 5 min)
- Install safety lock outs
- Check for conduits and wire sizes installed properly. Check area around inverter is cleaned and verify base is sealed
- Vacuum all debris from inverter
- Visually inspect for moisture intrusions
- Clean or replace air filters and clean air returns
- Check the tightness of cable termination
- Check for proper wire condition, sizing and insulation
- Check for proper labelling of cables
- Inspect Air filters
- Visually inspect inverter for external damage
- Check the functionality of inverter
- Check that the installation is neat and permanent
- Check inverter display and record all input and output voltages
- Clean area around inverter and verify base is sealed
- Shut down A.C/D.C breakers to inverter, power down the inverter
- Wait for inverter to discharge (approx. 5 min)
- Install safety lock outs
- Check for conduits and wire sizes installed properly Check area around inverter is cleaned and verify base is sealed
- Vacuum all debris from inverter
- Visually inspect for moisture intrusions
- Clean or replace air filters and clean air returns
- Check the tightness of cable termination
- Check for proper wire condition, sizing and insulation
- Check for proper labelling of cables
- Inspect Air filters
- Check for abnormal operating temperature

- Check for faulty fuses
- Power up the inverter
- Check the system is properly operational
- Check for ventilation condition (exhaust fan is working properly or not)
- Record Inverter and Meter power reading
- Check if Inverter inlet and outlet fan is working properly or not
- Check for Noise levels of inverter
- Torquing of terminals and fasteners
- Check for proper grounding levels
- The inverter mounted on ground or wall should be at a height convenient for reading its display
- Check for Inverter ground fault interruptions

H. Tracker

- Inspect flexible conduit and wires between moving modules for wear and cyclic motion
- Examine gear box for leakage of oil or grease
- Check for ground braids between movable torque tube and wear due to cyclic motion, replace if necessary
- For multiple tracker motors, examine array controlled by each tracker, and confirm they are in same positional orientation for all groupings
- Check there is no cracking at tube ends
- Inspect the wind sensor is positioned properly and functional
- Wherever available confirm date and time in tracker PLC's
- Check U-joint is greased properly
- Check for proper wire condition, sizing and insulation
- Check seal tight on trackers
- Check torque tubes and drive shafts to ensure that they haven't got loose by themselves
- Check array for backtrack shading
- Check for deposition of any dirt or dust
- Check for proper labelling
- Check sensors or mini controllers for its proper functioning
- Check for all fuses in the main controller

I. SCADA

- Check for proper wire condition, sizing and insulation
- Wire management must be proper and secured to weather station instrumentation (module temp sensor, ambient air temperature sensor, pyranometers etc.)
- Check that there is no moisture ingress in enclosures, seal as necessary
- Check for enclosures open and close hasps are functioning properly
- Check that wires are landed and secured properly within SCADA
- Cleaning inside of enclosures (dust, debris, insects etc.) vacuum with static-free vacuum
- Check for proper ventilation (fans must turn freely and functional) Check for deposition of any dirt or dust
- Verify all pyranometers are properly secured and mounted properly

J. Certification by Applicant

THIS IS TO CERTIFY THAT PLANT IS SUCCESSFULLY INSPECTED

Other Remarks :

Place: _____

Date: _____

Plant Owner Signature

Company's Seal & Signature

Name :

(* Note: Other/ if applicable. In case of more information, please add as attachments.)

DATASHEETS OF PV MODULE AND INVERTER



SolarEdge Three Phase Inverters for the Medium Voltage Grid

SE66.6K-SE100K



INVERTERS

Specifically designed to work with power optimizers

- Easy two-person installation – each unit mounted separately, equipped with cables for simple connection between units
- Balance of System and labor reduction compared to using multiple smaller string inverters
- Independent operation of each unit enables higher uptime and easy serviceability
- No wasted ground area: wall/rail mounted or horizontally mounted under the modules (10° inclination)
- Built-in module-level monitoring with Ethernet or cellular GSM
- Fixed voltage inverter for superior efficiency (98.1%) and longer strings
- Integrated DC Safety Unit with DC Safety Switch and optional surge protection & DC fuses – eliminates the need for external DC isolators
- Built-in RS485 Surge Protection Device, to better withstand lightning events



SolarEdge Three Phase Inverters for the Medium Voltage Grid SE66.6K-SE100K

	SE66.6K	SE100K	
OUTPUT			
Rated AC Power Output	66600	100000	VA
Maximum AC Power Output	66600	100000	VA
AC Output Voltage — Line to Line / Line to Neutral (Nominal)	480/277		Vac
AC Output Voltage — Line to Line Range; Line to Neutral Range	432 - 528 / 249.3 - 304.7		Vac
AC Frequency	50/60 ± 5		Hz
Maximum Continuous Output Current (per Phase) @277V	80	120	A
Grids Supported — Three Phase	3 / N / PE (WYE with Neutral)		V
Maximum Residual Current Injection ⁽¹⁾	250 per unit		mA
Utility Monitoring, Islanding Protection, Configurable Power Factor, Country Configurable Thresholds	Yes		
INPUT			
Maximum DC Power (Module STC), Inverter / Unit	90000 / 45000	135000 / 45000	W
Transformer-less, Ungrounded	Yes		
Maximum Input Voltage	1000		Vdc
Nominal DC Input Voltage	850		Vdc
Maximum Input Current	80	120	Adc
Reverse-Polarity Protection	Yes		
Ground-Fault Isolation Detection	350kΩ Sensitivity per Unit ⁽²⁾		
Maximum Inverter Efficiency	98.1		%
European Weighted Efficiency	98		%
Nighttime Power Consumption	< 12		W
ADDITIONAL FEATURES			
Supported Communication Interfaces ⁽³⁾	RS485, Ethernet, Cellular GSM (optional)		
RS485 Surge Protection	Built-in		
DC SAFETY UNIT			
DC Disconnect	1000V / 2 x 40A	1000V / 3 x 40A	
DC Surge Protection	Optional, Type II, field replaceable		
DC Fuses on Plus & Minus	Optional, 30A		
STANDARD COMPLIANCE⁽⁴⁾			
Safety	IEC-62109, AS3100		
Grid Connection Standards ⁽⁵⁾	VDE-AR-N-4105, G59/3, AS-4777, EN 50438, CEI-021, VDE 0126-1-1, CEI-016, BDEW		
Emissions	IEC61000-6-2, IEC61000-6-3, IEC61000-3-11, IEC61000-3-12		
RoHS	Yes		
INSTALLATION SPECIFICATIONS			
Number of units	2	3	
AC Output Cable	Cable gland — diameter 22-32; PE gland diameter 10-16	Cable gland — diameter 20-38; PE gland diameter 10-16	mm
DC Input ⁽⁶⁾	6 strings, 4-10mm ² DC wire, gland outer diameter 5-10mm	9 strings, 4-10mm ² DC wire, gland outer diameter 5-10mm	
AC Output Wire	Aluminum or Copper; L, N: Up to 70, PE: Up to 35	Aluminum or Copper; L, N: Up to 95, PE: Up to 50	mm ²
Dimensions (H x W x D)	Primary Unit: 940 x 315 x 260; Secondary Unit: 540 x 315 x 260		mm
Weight	Primary Unit: 48; Secondary Unit 45		kg
Operating Temperature Range	-40 to +60 ⁽⁷⁾		°C
Cooling	Fan (user replaceable)		
Noise	< 60		dB(A)
Protection Rating	IP65 — Outdoor and Indoor		
Bracket Mounted (Brackets Provided)			

⁽¹⁾ If an external RCD is required, its trip value must be ≥ 300mA per unit (≥ 600mA for SE66.6K; ≥ 900mA for SE100K)

⁽²⁾ Where permitted by local regulations

⁽³⁾ Refer to Datasheets -> Communications category on Downloads page for specifications of optional communication options: <http://www.solaredge.com/groups/support/downloads>

⁽⁴⁾ Pending

⁽⁵⁾ For all standards refer to Certifications category on Downloads page: <http://www.solaredge.com/groups/support/downloads>

⁽⁶⁾ Single input option per unit (up to 25mm²) available

⁽⁷⁾ For power de-rating information refer to: <https://www.solaredge.com/sites/default/files/se-temperature-derating-note.pdf>



GOLDI 60 SERIES

MONOCRYSTALLINE MODULE

KEY FEATURES

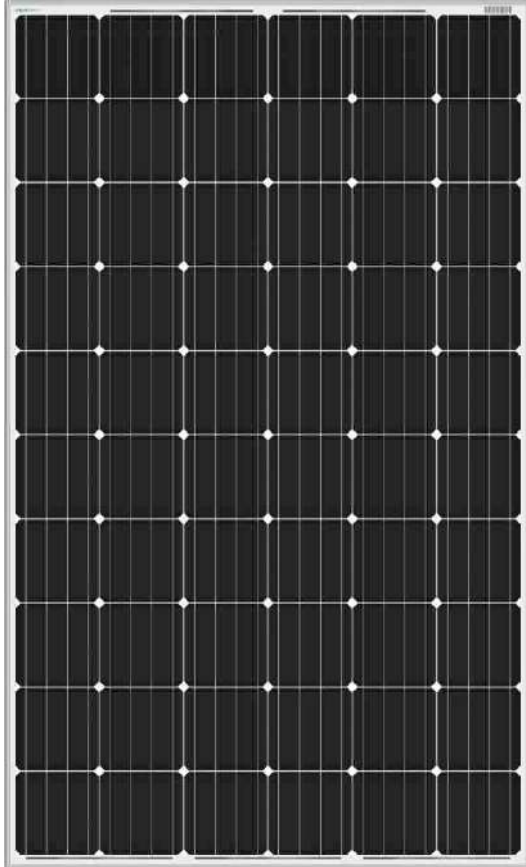

Excellent module conversion efficiency of up to 17.55%.



**PID resistant.
(IEC 62804 certified)**



Certified for extreme weather conditions. (snow load 5400 Pa, wind load 2400 Pa)



Salt mist and ammonia corrosion resistant. (IEC 61701 & IEC 62716 certified)



Multiple times EL inspection (Pre & Post Lamination) to ensure micro crack - free modules.



Up to +3% positive power output guaranteed.

Reliable Quality

- Powerful and stable: manufactured as per GOLDI GREEN's strict quality norms.
- 25 years output warranty.
- Certified from TUV SAAR & UL India.
- IP67 rated junction box for long-term weather endurance.
- 4BB design module improves reliability & module conversion efficiency.
- Certified for hail resistance.
- Manufactured in an ISO 9001:2015, ISO 14001:2015 & OHSAS 18001:2007 certified facility.
- Manufactured using highest grade raw materials from reputed international suppliers.

Application

- On-grid large scale utility system
- On-grid & off-grid residential system
- On-grid commercial / industrial roof top

**w : www.goldigreen.in e : info@goldigreen.in
India Toll Free No. : 1800 833 5511**

Electrical Parameter at STC[#]

Module Type	GOLDI	265MM	270MM	275MM	280MM	285MM
Capacity rating - Pmax(Wp)	265	270	275	280	285	
Power Tolerance (%)	0 ~ 3	0 ~ 3	0 ~ 3	0 ~ 3	0 ~ 3	
module efficiency (%)	16.32	16.63	16.94	17.25	17.55	
Rated Voltage- Vmp(V)	30.50	30.80	31.12	31.33	31.64	
Rated Current- Imp(A)	8.69	8.77	8.84	8.94	9.01	
Open Circuit Voltage- Voc(V)	38.35	38.55	38.70	38.85	39.00	
Short Circuit Current- Isc(A)	8.95	9.05	9.15	9.27	9.35	

Under Standard Test Conditions (STC) of irradiance of 1000 W/m², spectrum AM 1.5 and cell temperature of 25°C.

Electrical Parameter at NOCT[@]

Capacity rating - Pmax(Wp)	190.81	194.01	198.01	201.61	205.21	
Rated Voltage- Vmp(V)	27.84	28.12	28.41	28.60	28.89	
Rated Current- Imp(A)	6.85	6.91	6.97	7.05	7.10	
Open Circuit Voltage- Voc(V)	35.32	35.45	35.59	35.73	35.87	
Short Circuit Current- Isc(A)	7.12	7.20	7.28	7.37	7.44	

@NOCT irradiance of 800 W/m², ambient temperature of 20°C Wind speed 1m/sec

Temperature coefficients (TC)

Temperature Coefficient (Voc)	-0.33 % /°C
Temperature Coefficient (Isc)	0.034% /°C
Temperature Coefficient (Pmax)	-0.42 % /°C

Permissible Operating Conditions

Temperature range	-40°C to + 85°C
Maximum system voltage	1000 V DC
NOCT	45± 2°C
Maximum surface load	Tested up to 5400 Pa according to IEC 61215
Hail resistance	Maximum diameter of 25 mm with velocity 23 m/s

Mechanical Specification

Solar Cell	60 pcs Monocrystalline Silicon (156 mm x 156 mm, 0~+1mm),4BB, PID free
Cell encapsulation	Ultra - clear PID free EVA (Ethylene-Vinyl- Acetate)
Backside	UV protected reflective backsheet
Frame	Silver Anodised Aluminum Alloy (screwless)
Front glass	3.2 mm, High transmission, AR Coated Tempered Glass
Dimensions (L x W x H)	1640 mm x 990 mm x 36 mm
Weight	18.3 kgs
Junction box	IP 67 certified 4-rail, 3 diodes junction box
Cable & Connectors	Solar cable 1000 mm length, 4 mm ² , MC4 compatible connectors
Application Class	Class A
Electrical Safety	Class II
Fire Safety	Class C (Type 1)

Guarantees and Certifications

Product warranty**	10 years
Performance guarantee**	Guaranteed Output power :- 90% for 10 years, and 80% for 25 Years
Approvals and certificates	IEC 61215, IEC 61730, UL 1703, IEC 61701, IEC 62716, IEC 62804, CE

Packing information

Container	20'GP	40'HC
Pallets/ container	10	28
Modules / container	290	812

GOLDI 60 SERIES

MONOCRYSTALLINE MODULE

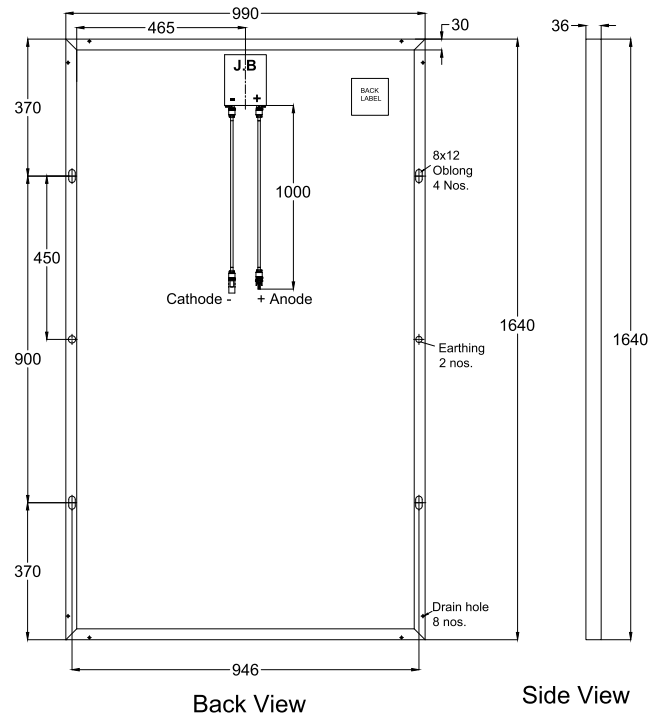

All dimensions are in mm

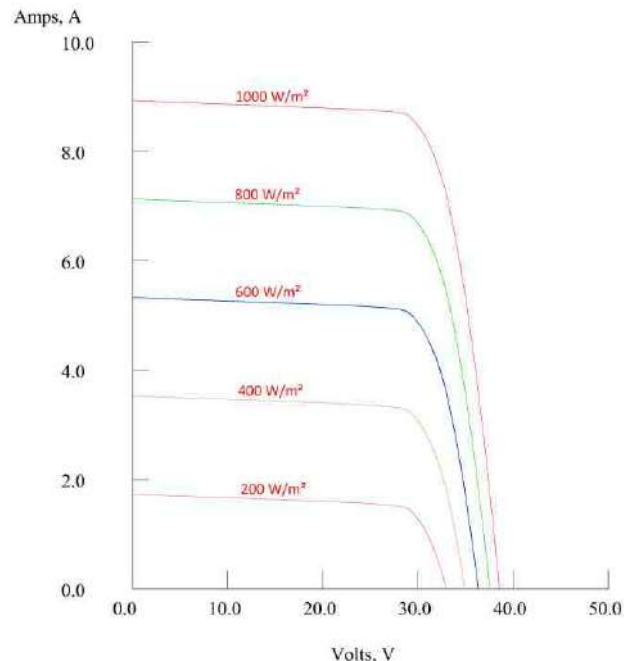

** Refer to Goldi Green's warranty document for terms and conditions.

Due to constant product modifications, Goldi Green reserves the right to amend the above specifications without prior notice. Please confirm your exact requirement with our sales representative before placing your order.

KEY FEATURES



Excellent module conversion efficiency of up to 16.79%.



PID resistant.
(IEC 62804 certified)



Certified for extreme weather conditions. (snow load 5400 Pa, wind load 2400 Pa)



Salt mist and ammonia corrosion resistant. (IEC 61701 & IEC 62716 certified)



Multiple times EL inspection (Pre & Post Lamination) to ensure micro crack - free modules.



Up to +3% positive power output guaranteed.

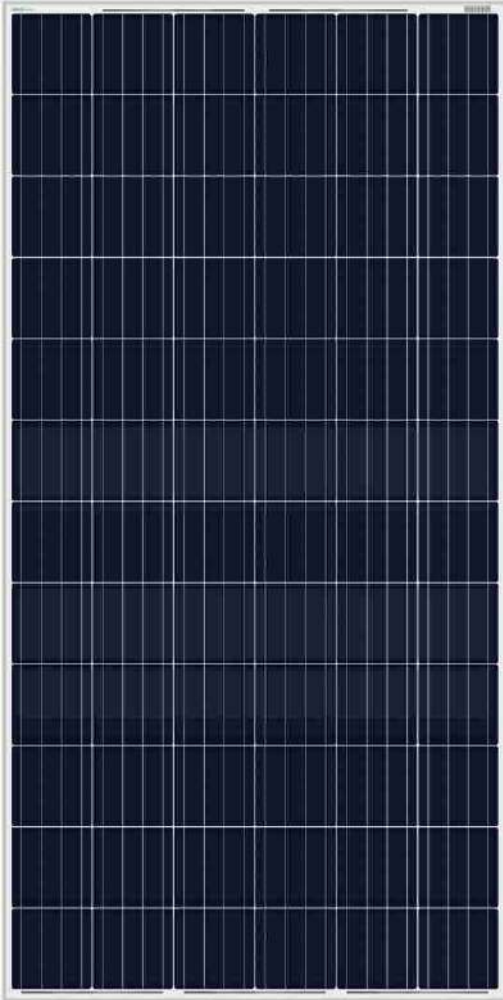

Reliable Quality

- Powerful and stable: manufactured as per GOLDI GREEN's strict quality norms.
- 25 years output warranty.
- Certified from TUV SAAR & UL India.
- IP67 rated junction box for long-term weather endurance.
- 4BB design module improves reliability & module conversion efficiency.
- Certified for hail resistance.
- Manufactured in an ISO 9001:2015, ISO 14001:2015 & OHSAS 18001:2007 certified facility.
- Manufactured using highest grade raw materials from reputed international suppliers.

Application

- On-grid large scale utility system
- On-grid & off-grid residential system
- On-grid commercial / industrial roof top
- Solar Pumping System

w : www.goldigreen.in e : info@goldigreen.in
India Toll Free No. : 1800 833 5511

Electrical Parameter at STC[#]

Module Type	GOLDI	300PM	305PM	310PM	315PM	320PM	325PM
Capacity rating - Pmax(Wp)		300	305	310	315	320	325
Power Tolerance (%)		0 ~ 3	0 ~ 3	0 ~ 3	0 ~ 3	0 ~ 3	0 ~ 3
module efficiency (%)		15.50	15.76	16.02	16.28	16.53	16.79
Rated Voltage- Vmp(V)		36.60	36.80	36.90	37.00	37.10	37.20
Rated Current- Imp(A)		8.20	8.30	8.42	8.52	8.63	8.74
Open Circuit Voltage- Voc(V)		45.20	45.40	45.70	46.00	46.20	46.40
Short Circuit Current- Isc(A)		8.60	8.70	8.80	8.90	9.00	9.10

[#] Under Standard Test Conditions (STC) of irradiance of 1000 W/m², spectrum AM 1.5 and cell temperature of 25°C.

Electrical Parameter at NOCT[@]

Capacity rating - Pmax(Wp)	216.01	219.61	223.21	226.81	230.41	234.01
Rated Voltage- Vmp(V)	33.41	33.60	33.69	33.78	33.87	33.96
Rated Current- Imp(A)	6.46	6.54	6.64	6.72	6.80	6.89
Open Circuit Voltage- Voc(V)	41.57	41.75	42.03	42.31	42.49	42.67
Short Circuit Current- Isc(A)	6.84	6.92	7.00	7.08	7.16	7.24

[@]NOCT irradiance of 800 W/m², ambient temperature of 20°C Wind speed 1m/sec

Temperature coefficients (TC)

Temperature Coefficient (Voc)	-0.33 % /°C
Temperature Coefficient (Isc)	0.034% /°C
Temperature Coefficient (Pmax)	-0.42 % /°C

Permissible Operating Conditions

Temperature range	-40°C to + 85°C
Maximum system voltage	1000 V DC
NOCT	45± 2°C
Maximum surface load	Tested up to 5400 Pa according to IEC 61215
Hail resistance	Maximum diameter of 25 mm with velocity 23 m/s

Mechanical Specification

Solar Cell	72 pcs Polycrystalline Silicon (156 mm x 156 mm, 0~+1mm),4BB, PID free
Cell encapsulation	Ultra - clear PID free EVA (Ethylene-Vinyl- Acetate)
Backside	UV protected reflective backsheets
Frame	Silver Anodised Aluminum Alloy (screwless)
Front glass	3.2 mm, High transmission, AR Coated Tempered Glass
Dimensions (L x W x H)	1955 mm x 990 mm x 42 mm
Weight	22.0 kgs
Junction box	IP 67 certified 4-rail, 3 diodes junction box
Cable & Connectors	Solar cable 1200 mm length, 4 mm ² , MC4 compatible connectors
Application Class	Class A
Electrical Safety	Class II
Fire Safety	Class C (Type 1)

Guarantees and Certifications

Product warranty**	10 years
Performance guarantee**	Guaranteed Output power :- 90% for 10 years, and 80% for 25 Years
Approvals and certificates	IEC 61215, IEC 61730, UL 1703, IEC 61701, IEC 62716, IEC 62804, CE

Packing information

Container	20'GP	40'HC
Pallets/ container	10	24
Modules / container	250	600

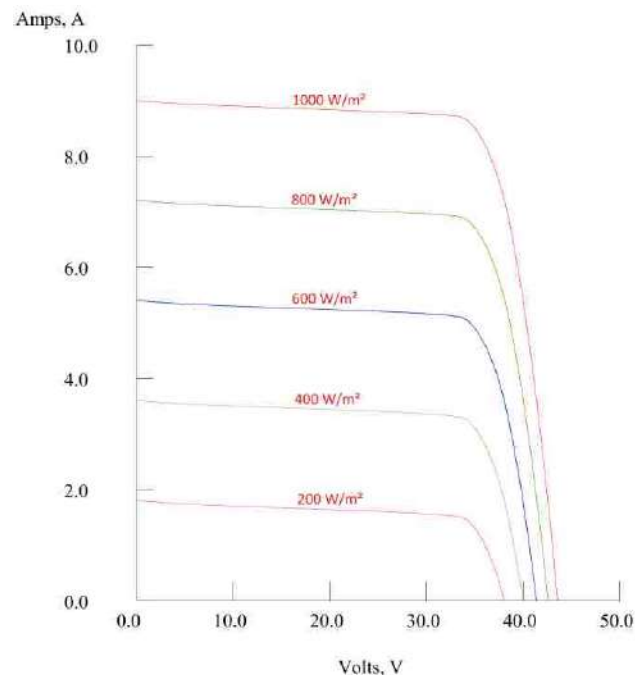
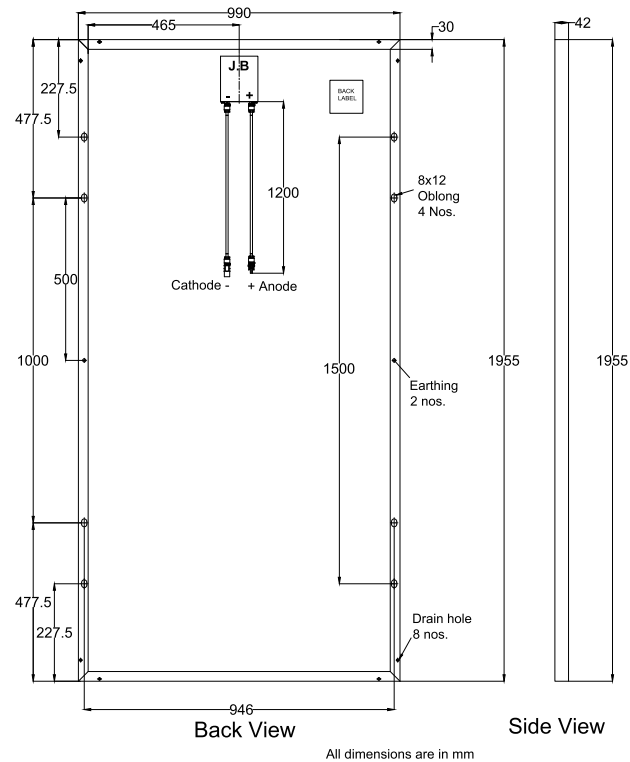

** Refer to Goldi Green's warranty document for terms and conditions.

Due to constant product modifications, Goldi Green reserves the right to amend the above specifications without prior notice. Please confirm your exact requirement with our sales representative before placing your order.



Ref. Certif. No.

US-27892-UL

IEC SYSTEM FOR MUTUAL RECOGNITION OF TEST
CERTIFICATES FOR ELECTRICAL EQUIPMENT
(IECEE) CB SCHEME

SYSTEME CEI D'ACCEPTATION MUTUELLE DE
CERTIFICATS D'ESSAIS DES EQUIPEMENTS
ELECTRIQUES (IECEE) METHODE OC

CB TEST CERTIFICATE**CERTIFICAT D'ESSAI OC**

Product
Produit

Photovoltaic (PV) Module(s)

Name and address of the applicant
Nom et adresse du demandeur

Goldi Green Technologies Pvt Ltd
Block No.149, Plot No. J & K1, Bs. IOC Petrol Pump
Pipodara NH 8, Dist
Surat, GJ 394110 India

Name and address of the manufacturer
Nom et adresse du fabricant

Goldi Green Technologies Pvt Ltd
Block No.149, Plot No. J & K1, Bs. IOC Petrol Pump
Pipodara NH 8, Dist
Surat, GJ 394110 India

Name and address of the factory
Nom et adresse de l'usine

Goldi Green Technologies Pvt Ltd
Block No.149, Plot No. J & K1, Bs. IOC Petrol Pump
Pipodara NH 8, Dist
Surat, GJ 394110 India

Note: When more than one factory, please report on page 2
Note: Lorsque il y a plus d'une usine, veuillez utiliser la 2^{eme} page

Ratings and principal characteristics
Valeurs nominales et caractéristiques principales

Additional Information on page 2
Maximum system voltage: 1000 V
Maximum over-current protection rating: 15 A
See specific model rating in table in the CB Test report, in GPI

Trademark (if any)
Marque de fabrique (si elle existe)



Type of Manufacturer's Testing Laboratories used
Type de programme du laboratoire d'essais
constructeur

Model / Type Ref.
Ref. De type

GOLDI140MM_36S, GOLDI140PM_36S, GOLDI145MM_36S,
GOLDI145PM_36S, GOLDI150MM_36S, GOLDI150PM_36S,
See Page 2

Additional information (if necessary may also be
reported on page 2)
Les informations complémentaires (si nécessaire,,
peuvent être indiqués sur la 2^{eme} page

Additional Information on page 2

A sample of the product was tested and found
to be in conformity with
Un échantillon de ce produit a été essayé et a été
considéré conforme à la

IEC 61215(ed.2)

As shown in the Test Report Ref. No. which forms part
of this Certificate
Comme indiqué dans le Rapport d'essais numéro de
référence qui constitue partie de ce Certificat

E482243-4787325374. 1.1-D1-CB-TRF issued on 2016-06-27

This CB Test Certificate is issued by the National Certification Body
Ce Certificat d'essai OC est établi par l'Organisme **National de Certification**



- UL (US), 333 Pfingsten Rd IL 60062, Northbrook, USA
- UL (Demko), Borupvang 5A DK-2750 Ballerup, DENMARK
- UL (JP), Marunouchi Trust Tower Main Building 6F, 1-8-3 Marunouchi, Chiyoda-ku, Tokyo 100-0005, JAPAN
- UL (CA), 7 Underwriters Road, Toronto, M1R 3B4 Ontario, CANADA

For full legal entity names see www.ul.com/ncbnames

Date: 2016-06-28

Signature:

Jolanta M. Wroblewska

UL CERTIFICATE FOR SELECTED TESTS

The product Photovoltaic Modules has been tested by UL International Germany GmbH and found to comply in accordance with the Test Procedure indicated on this report.

Project Number/ **4787646204 / 4787646204-01**
Certificate No:

Issue Date: **2017-01-20**

Issued to: **Goldi Green Technologies Pvt Ltd**

Manufacturer: **Goldi Green Technologies Pvt Ltd**
BLOCK NO.149, PLOT NO. J & K1, BS. IOC PETROL PUMP
PIPODARA NH 8, DIST
SURAT, GJ, 394110 INDIA

Tested Model: **Model(s): GOLDI320PM_72S**
Have been investigated by UL in accordance with the Test procedure indicated on this Certificate.

Test Procedure: **IEC 62716 1st edition : 2013-06 "Photovoltaic (PV) modules – Ammonia corrosion testing"**

Test Result(s)/ **Modules under test complied with the requirements of test**
Test Report No: **procedure. Details of construction (BOM) and test results can be found in Test Report #4787646204.**

Additional Test **The samples were subjected to 20 Cycles of the ammonia sequence.**
Information: **Each cycle include:**

- 1) 8h with 6667ppm NH₃ @ 60±3°C and 100%rH (including heating up)
- 2) 16h with 0ppm NH₃ @ 18-28°C and max. 75%rH



2017-01-20
Marijo Cosic
Laboratory Leader

Test results apply only to the sample(s) actually tested by (UL Legal Entity). The client provided all of the test samples for testing by UL. UL did not select the samples or determine whether the samples provided were representative of other manufactured products. UL has not established Follow-Up Service or other surveillance of the product. The client and or manufacturer are solely and fully responsible for conformity of all products to all applicable standards, specifications or requirements. UL Logo and Marks shall not be used in connection with the above tested product(s). Only those products bearing the UL Listing and Classification Marks should be considered as being covered by UL's Listing, Classification and Follow-Up Service. Look for the UL Listing and Classification Mark on the product. This UL Certificate for Selected Tests does not indicate that the sample(s) of the product described herein has been investigated and found to have been in compliance with the entire Standard(s) indicated on this Certificate, nor does it indicate compliance with the UL Type Examination Certificate Program Requirements.

Issuing Body **UL International Germany GmbH**

TEST CERTIFICATE

The product Photovoltaic Module has been tested by UL India Private Limited and found to comply in accordance with the Test Procedure indicated on this report.

Certificate Number: 4787672335-S1

Issue Date: 13-12-2016

Issued to: GOLDI GREEN TECHNOLOGIES PVT. LTD.
BLOCK NO.149, PLOT NO. J & K1, BS. IOC PETROL PUMP,
PIPODARA NH 8, DIST, SURAT , GJ 394110, INDIA

Tested Model: GOLDI300PM_72S, 300W

Test Procedure: Proneness Test for Potential-Induced-Degradation (PID)

Tested Result: Modules under test were not PRONE to PID -> PASS

Standard(s): PID (Potential Induced Degradation) Testing of Solar Photovoltaic Modules as per IEC 62804 – Test Methods for the Detection of Potential Induced Degradation Part 1: Crystalline Silicon Photovoltaic Modules. Edition 1.0, 2015-08 (Negative Grounding)

Test Condition: Relative Humidity -> $85 \pm 3\%RH$, Ambient Temperature -> $85 \pm 2^{\circ}C$, Applied Potential -> 1000V, Test duration -> 3 Cycles of 96 Hours, Test criteria - Power loss <5% at 1000W/m² after PID Test. As per MNRE Requirement.

Disclaimer: Test results apply only to the sample(s) actually tested by UL-India Private Limited. The client provided all of the test samples for testing by UL. UL did not select the samples or determine whether the samples provided were representative of other manufactured products. UL has not established Follow-Up Service or other surveillance of the product. The client and or manufacturer are solely and fully responsible for conformity of all products to all applicable standards, specifications or requirements. UL Logo and Marks shall not be used in connection with the above tested product(s). Only those products bearing the UL Listing and Classification Marks should be considered as being covered by UL's Listing, Classification and Follow-Up Service. Look for the UL Listing and Classification Mark on the product.

Issued By:

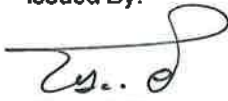

Mahesh V

UL India Private Limited.

Authorized By:

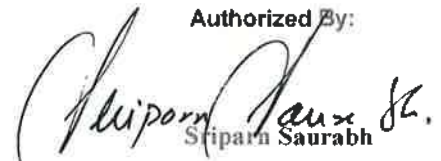

Shipam Saurabh

UL India Private Limited



REFERENCES

- [1] <http://mnre.gov.in/file-manager/UserFiles/Best-Practices-Guide-on-State-Level-Solar-Rooftop-Photovoltaic-Programs.pdf>
- [2] [file:///C:/Users/Test/Downloads/yBcNs6YSXmPNkPPBmsFCTy8QiCpHaEVOFxbyszFEbVSAkhCLPHOj7Kz%20\(1\).pdf](file:///C:/Users/Test/Downloads/yBcNs6YSXmPNkPPBmsFCTy8QiCpHaEVOFxbyszFEbVSAkhCLPHOj7Kz%20(1).pdf)
- [3] <https://www.wholesalesolar.com/solar-information/battery-maintenance>
 - [i] <http://www.exsolar.co.za/mono-vs-poly-vs-thin-film-panels.html>
 - [ii] http://www.katko.com/products?product_group=104
 - [iii] http://raglobal.in/?page_id=244
 - [iv] <https://www.indiamart.com/saikiranelectrical/electical-earthing.html>
 - [v] <https://solarmagazine.com/do-not-place-crops-on-photovoltaic-modules/>
 - [vi] https://lh3.googleusercontent.com/uCgkvL71ALgwdWh3Guexzfz8bLdLn0klYTEaCbKW_S7_gZyFdSu0njPTRUnVdRxe3aK=s149
 - [vii] <http://www.renewableenergyworld.com/articles/2009/02/shade-happens-54551.html>
 - [viii] <http://www.solar-installations.net/solar-panel-cleaning-and-maintenance-bristol>
 - [ix] <https://www.pi-berlin.com/en/eva-film-test.html>
 - [x] <http://exasun.com/durability/>
 - [xi] <http://www.windowdoctors.net/solar-panels.html>
 - [xii] <https://www.aerialpower.com/solarbrush/>
 - [xiii] <https://www.civicsolar.com/support/installer/articles/string-layout-shade-mitigation>
 - [xiv] <http://www.30north.com.au/taxonomy/term/98>
 - [xv] <https://solarmagazine.com/do-not-place-crops-on-photovoltaic-modules/>
 - [xvi] http://techon.nikkeibp.co.jp/atclen/news_en/15mk/102600127/?SS=imgview_msbe&FD=49498919
 - [xvii] http://rollingwash.net/eco_how_it_works.html
 - [xviii] <https://www.linkedin.com/pulse/water-free-solar-panel-cleaning-robot-solar-energy-solution-provider-6022906571967787008>
 - [xix] <http://www.artronic.com.tr/yenilenebilir-enerji-cozumleri/aeg-solar-inverter-cozumleri>
 - [xx] https://lh3.googleusercontent.com/0byYfWN8NWqOPRkR-pt8RfDzqu1FYp0bD3MBB_J-3DpjREx-fk0-OpSvOpJwr6e5tAtCtms=s136
 - [xxi] <http://www.eqmagpro.com/huawei-string-inverters-increasingly-sought-in-the-indian-market/>
 - [xxii] https://lh3.googleusercontent.com/IE01Tmob7wBmH1iYf1Ecgftq_KYz2oFFyKGTuQfjbPrAcLKDE1kouNvrW1xSBCEh3CyKJA=s128
 - [xxiii] https://lh3.googleusercontent.com/vKzo4zsl6vUNWwM4HyjDjuZ8lou7SZsApzCCaUjuzgVUA0T_qLx9tf3__goa6lj47anK=s151
 - [xxiv] https://lh3.googleusercontent.com/Fbu2gqzxKKmb9V1IFpEFKqinhyEy2YIhkg6l_MihDWJ-eXp5t5yKPOeA7IH5cxqoY87a=s159
 - [xxv] <https://lh3.googleusercontent.com/zcjdICWTVrc8XRdijh8xW95BypgJKGfzBlkOHsxB5YL045NCRcFuyF4RFslvz1PUd-SX2c=s85>

- [xxvi] https://lh3.googleusercontent.com/pFfdVBe_WUuO-fhMXip0Bf-3E1bOG9nFzk33JvWsSuoINMfD36hWGhbKj7nDSBso_Lbr5AM=s88
- [xxvii] <https://lh3.googleusercontent.com/AXXfSlu16aRbgL46sgqAwaFYKbRB0U3srLpqnXOqbl5vZooZl0i3JKeSypaJy4wUqHmHwQ=s152>
- [xxviii] <http://www.eqmagpro.com/sollega-demonstrates-fastrack510-flat-roof-racking-and-new-fastrack-string-inverter-mount-at-intersolar-2016/>
- [xxix] <https://lh3.googleusercontent.com/Be9m1fhTFq0U5uTf6xvJQhv1NS1osl5a0GjK7EWh5KYmB2V-luqCez1cb9H0UEc7RfXM=s85>
- [xxx] https://lh3.googleusercontent.com/PIZgkoz8O0QEU3Ev2_U3Kapj4sNpvCLzr-p-ofqlyopMOEk-LbL4DaEMhBMUMpKSgukv6A0=s114
- [xxxi] <https://lh3.googleusercontent.com/KlKzcd98guHw1yIZld-DJHvEEcQ-0w1PvTuK9y7JGgyH33i7gLVroPgQRtBMO4ZY06PKAQ=s170>
- [xxxii] https://lh3.googleusercontent.com/5xKV68nPOEgSO6ZQUi24uYIOwt_WPnG5Jac80dxoJzmYINL_CHoNGyaCaojQhmN36inERC0=s128
- [xxxiii] <https://lh3.googleusercontent.com/aJwTPQOd6Wikwdtd06jtw0mqH8SRy0es0dunZZn0B4zrqdbmyj0zXt5MvCm-JVMhAZt5=s159>
- [xxxiv] https://lh3.googleusercontent.com/onNJRhn2DmNPPQNkDWt0DKW6u1_6ZBHOnjEdVrtgITQeeG9zZc_LV_HJtfaKZ5uFvVP4=s85
- [xxxv] https://lh3.googleusercontent.com/R_riRuJxR93V9Cc8Lm9d5LB84c6xFvmH6WVmHtKG984CHFRrtVmg57X4e6_f0QOFJmTz4ic=s145
- [xxxvi] <https://lh3.googleusercontent.com/FWOthPUhBMF8W2OzuPoy2nztBUmYx2ZxO5Oqguyw4X6JISQJdVPqFmEJ6B6f-HE7JuW2II8=s128>
- [xxxvii] <http://www.yougen.co.uk/blog-entry/1659/Energy+companies+confuse+customers+over+export+meters+for+feed-in+tariff+/>
- [xxxviii] <https://hubpages.com/autos/How-to-Replace-Battery-Clamps>
- [xxxix] <http://www.racerocks.ca/energy/the-integrated-energy-project-solar-energy-at-race-rocks/>
- [xl] https://lh3.googleusercontent.com/bFdkMN_nGtEPKinukhgDAgHyj4hjPlmu2SYrOj3iApPYycRPIDN-yD_sxfVwauXlYJi6Rg=s95
- [xli] https://lh3.googleusercontent.com/w_n3KlRxqfZcdCBDjWU0aHb9K61zEbr011VoeN7_qLSCVQ8WYokJ155MWzw5LcO3nJafWkY=s147
- [xlii] <https://www.motherearthnews.com/renewable-energy/solar-power/solar-power-zm0z12aszphe>
- [xlii] <https://www.homepower.com/articles/solar-electricity/design-installation/code-corner-residential-pv-systems-common-code>
- [xlirii] https://lh3.googleusercontent.com/6b8VnCaDDbBOuiwQQHCu6ArqWE_oVdQdnilUU0_nZRI5xfiB5xm4ljKLCNDS5GGq6J18=s170
- [xliv] <http://ambriefonline.com/2015/07/29/solar-solutions-flexicon-conduit-systems-offer-superior-cable-protection-for-solar-pv-installations/>
- [xlv] https://lh3.googleusercontent.com/z29fS62X_uQfw1iFvkc1blOrCUy1CMXRdtVGDZAFrm0bT3lzbIse3ib0OQR2d0gy00EFsWQ=s114
- [xlvi] <https://www.wikihow.com/Clean-Corroded-Car-Battery-Terminals>
- [xlvii] https://lh3.googleusercontent.com/zrhM_OqHIERK-d3yHG0_QrfyphvLHwK_nmTQBC3wXYq-YpN9MTZYdwYM07yduDDDG4zJkts=s105
- [xlviii] <http://www.repairkitsuk.com/5.html>
- [xliv] <https://fr.wikihow.com/nettoyer-l%27oxydation-et-la-corrosion-des-batteries>
- [I] <https://fr.wikihow.com/nettoyer-l%27oxydation-et-la-corrosion-des-batteries>

- [li] https://lh3.googleusercontent.com/cjAryqzu6uQ30EWZxo_cXXVT69eN48JbvL_-WGWK3gFiwiu2R2N0ltys6Gqx48cocR2oMRM=s127
- [lii] https://lh3.googleusercontent.com/RffiMW86_ONFBGJHLOdzSPUFx8N8QNbeJ4rXy4maCIU6ioRTo4dTMBvCrCvuYSQLVr1Wyqo=s114
- [liii] <https://lh3.googleusercontent.com/KnQ5JVwLdgmKaB8SGA3kJwjEszZwKeCBLy1-HdLe4NTzOyCpw8PfnlvUEAIWCJ-HvCVBFA=s85>
- [liv] https://lh3.googleusercontent.com/X2Pefj4ye7i9jFpDR6lfad7hmBEmVIJ8MR8g5kj-F8_0Le7OIMxaf1RZZZga5XVfihwhk-l=s113
- [lv] <http://funtasticpics.blogspot.in/2008/08/health-and-safety-measures.html>
- [lvi] https://lh3.googleusercontent.com/1mL_32Q_WOoCY4PbrmQqI9qhDjXveBvLVCKtcbuLoqReiMbOxyLI8Y8c03dIVcs8fvPFIQ=s85
- [lvii] <http://tanishmultiservices.com/services.php>
- [lvii] https://lh3.googleusercontent.com/lzd3kkmkBdvYsh2dNFXFY_sNqvB_yHcXQB0wMICcwJw5RBDHFypb8pOaOfoLdclPSYZi=s92
- [lviii] <https://lh3.googleusercontent.com/yKXOx-4VMK6QxCz6T-qSMERGiHq0sKsCaaJWQX0VV26ClirHdAlkWpLuCtz8B-Ke1VPI=s85>
- [lix] https://lh3.googleusercontent.com/tNWPZBo2NOePKJORXFjHE-GSzn-tWU0XzB51RMXGa3X4IM0n9EFhI7_9wlfACWawldzRIQ=s92
- [lx] https://lh3.googleusercontent.com/fuykQdnkqN5b6pDTBZ3A23mVvf9OkGI_v0J55018ST4OsYBVosdj84g90l-qs-wLsb0QxLA=s149



Gujarat Energy Research & Management Institute

1st Floor, Energy Building,
Pandit Deendayal Petroleum University,
Raisan Village, Gandhinagar - 382 007.

Phone: +91 79 23275361 | Fax : +91 79 23275380 | Email: information@germi.org